

Non-linear reduction in nitrous oxide emissions through alternative management of groundnut and millets in India

Results and discussion of a multi-year nitrous oxide emissions measurement study conducted in semi-arid peninsular India

Kritee Kritee, Drishya Nair, Somashekar Balakrishna, Leela Venkataiah, Shalini Reddy, Obulapathi Dava, Ramakrishna V. Dokka, Daniel Zavala-Araiza, Joseph Rudek, Terrance Loecke, V. Manikandan, Jeremy Proville, Udaya Vaddi and Richie Ahuja

About Environmental Defense Fund

One of the world's leading international nonprofit organizations, Environmental Defense Fund creates transformational solutions to the most serious environmental problems. To do so, EDF links science, economics, law and innovative private-sector partnerships. With more than 2.5 million members and offices in the United States, China, Mexico, Indonesia and the European Union, EDF's scientists, economists, attorneys and policy experts are working in 28 countries to turn our solutions into action.

Citation

Please cite this report as follows: Kritee K., Drishya Nair, Somashekar Balakrishna, Leela Venkataiah, Shalini Reddy, Obulapathi Dava, Ramakrishna V. Dokka, Daniel Zavala-Araiza, Joseph Rudek, Terrance Loecke, V. Manikandan, Jeremy Proville, Udaya Vaddi and Richie Ahuja (2022). Non-linear reduction in nitrous oxide emissions through alternative management of groundnut and millets in India: Results and discussion of a multi-year nitrous oxide emissions measurement study conducted in semi-arid peninsular India. Published by Environmental Defense Fund, New York, NY.

Non-linear reduction in nitrous oxide emissions through alternative management of groundnut and millets

Kritee Kritee¹, Drishya Nair^{1,2}, Somashekar Balakrishna³, Leela Venkataiah³, Shalini Reddy⁴, Obulapathi Dava⁴, Ramakrishna V. Dokka⁵, Daniel Zavala-Araiza¹, Joseph Rudek¹, Terrance Loecke⁶, V. Manikandan⁵, Jeremy Proville¹, Udaya Vaddi¹ and Richie Ahuja¹

¹ Environmental Defense Fund, 2060 Broadway St, Ste 300, Boulder, Colorado 80302, United States of America

² Fair Climate Network, ADATS Campus, Bagepalli 561 207 Karnataka, India

³ Social Animation Centre for Rural Education and Development, 25 Sunandamma Building, Basavaraj Layout, Near S.B. Kalyana Mantapa Nalligudda Tank (NT) Road, Bidadi, Ramanagara 562109 Karnataka, India

⁴ Accion Fraternal Ecology Center, Upparapalli Road, Bangalore Highway, Anantapur 515 002, Andhra Pradesh, India

⁵ The Timabktu Collective, Chennekothapalli Village, National Highway 7, Anantapur District, Andhra Pradesh 515101

⁶ University of Kansas Lindley Hall, 1475 Jayhawk Blvd., Lawrence, Kansas 66045 United States of America

Executive summary

Agricultural soils account for about two-thirds of the global anthropogenic flux of nitrous oxide (N₂O), the third most important greenhouse gas after carbon dioxide and methane. Most of the increasing levels of N₂O emissions over the past four decades can be attributed to the inefficient use of nitrogen fertilizers as farmers pursue higher crop productivity. Therefore, fertilizer use is a subject of country-level climate-mitigation conversations as well as international discussions within the United Nations Framework Convention on Climate Change (UNFCCC). If we have to meet global food security goals while avoiding catastrophic climate crisis, then we should invest in identifying better fertilizer management practices that accomplish the three goals of climate-smart farming (i.e., yield and profit improvement, climate resilience and climate mitigation). Additionally, we should improve estimations of global agricultural N₂O emissions through more rigorous calculation of N₂O emission factors (EF) in different agro-ecological regions across the world. Accurate determination of emission factors used to estimate current and future N₂O emissions will have a profound impact on which geographies, crops or soil types are targeted for promotion of climate-smart farming practices around the world. Accurate determination of emission factors is especially important for the cropping systems managed by smallholder farmers in emerging economies and in the tropical parts of the world where soil quality is generally poorer, there is a wider range in rates of nitrogen use among farmers and/or

where the number of technical studies reporting N₂O emissions is limited as compared to other parts of the world.

India's latest biennial national communication to UNFCCC released in 2021 estimated nitrous oxide (N₂O) emissions from agricultural soils to be about 250 Gg of N₂O with the use of inorganic fertilizers contributing to over 75% of these emissions. The Indian government uses a linear and fixed emission factor of 0.58% for estimating these N₂O emissions. This Indian emission factor implies that there is a linear relationship between nitrogen fertilizer application rate and N₂O emissions. Specifically, it implies that for every 100 kilogram (kg) of nitrogen in fertilizers applied by a farmer in India, 0.58 kg will get converted to nitrogen in nitrous oxide. In contrast, scientists across the world accept that the emission factors vary widely and that there is a faster than linear (i.e., superlinear) increase in N₂O emissions with increasing nitrogen inputs.

This technical report investigates and attempts to answer two questions.

1. As compared to business-as-usual practices, can alternative practices that involve application of lower N fertilizers rates maintain (or even increase) yields and incomes of smallholder farmers who grow groundnut and millets in India?
2. Do N₂O emissions from Indian cropping systems also change non-linearly in response to changing nitrogen use?

Below, we explain results from our multi-year study conducted at five farms in India between 2012 and 2015 to measure N₂O emissions from up to four different nitrogen application rates for three different Indian cropping systems. In brief, we show that carefully chosen alternative practices (with lower N rates) can indeed achieve a triple win such that farmers get better or similar yields, similar or higher profits and much less N₂O emissions. Despite 65-80% lower total N application rates, the Low-N alternative practices led to similar or higher yields when compared with High-N business-as-usual treatments. While our dataset is limited to just a few farms, our Low-N treatments did result in 5-25% higher net revenue than high N, business-as-usual "farmer" treatments. Our study clearly shows that reducing excess N application rates in these systems can lead to lower N₂O emissions while increasing or maintaining yields and profits. These results should encourage researchers and practitioners to investigate other systems where reducing N application could improve productivity and profits while also leading to environmental benefits.

Additionally, there is indeed a faster than linear (i.e., superlinear) increase in N₂O emissions with increasing nitrogen inputs in Indian cropping systems, which is similar to the trends observed in scientific studies across the world. Our results also suggest that Indian N₂O

budgets might be significantly altered by replacing the constant Indian 0.58% EF with an N-rate–dependent non-linear EF. In particular, this change would lower N₂O emissions estimates in regions where farmers predominantly use low rates of nitrogen fertilizers while increasing N₂O emissions estimates in regions where high rates of nitrogen fertilizers beyond crop needs are common. We note that if linear equations are forced on our dataset, the resulting EFs for the entire range of fertilizer rates used in our study will be between 1.8 and 3.5% for different crops. These “forced” linear EFs seem significantly higher than both the average global EF recommended by United Nations’ Intergovernmental Panel on Climate Change (1%) and the regional EF used by the Indian Government (0.58%). However, it is crucial to understand that our N₂O data is non-linear and implies N₂O emissions that are similar to (or even lower than) those based on Indian EFs of 0.58% when N application rates are less than 20-25 kg N per hectare. Our data implies significantly higher EFs as compared to 0.58% or 1% only when N rates are much higher than crop N needs. Thus, both IPCC and the Indian government’s EFs could be significantly underestimating the amount of the mitigation potential of different climate smart farming practices in India when N applications rates are higher than crop needs.

In line with previous research in other parts of the world, this report suggests that the largest agricultural mitigation gains (with respect to both N₂O emissions per unit area and N₂O emissions per unit yield) in India are to be made where fertilizer N is applied in great excess of the crop needs (e.g., in many irrigated areas of the Indo-gangetic plain in India). Additionally, an understanding of non-linear changes in N₂O emissions can inform N use efficiency in rainfed cropping systems in India which currently involve low N application rates where relatively small increase in N₂O emissions will occur when farmers use modestly higher rates of nitrogen fertilizers to improve their yields.

This report shows clearly that it is possible to improve farmers’ yields and income while reducing climate impacts of crop production in India. With sufficient support for development and implementation, tailored advisory tools that help Indian farmers optimize their N fertilizer inputs have potential to achieve these outcomes. In the interest of global food and economic security, we also recommend continued research on yield-scaled N₂O response curves from other tropical and developing parts of the world.

Technical Abstract

Nitrous oxide (N₂O) emissions response curves for crops grown outside temperate regions have been rare and have thus far arrived at conflicting conclusions. Most studies reporting N₂O emissions from tropical cropping systems have examined only one or two N fertilizer application rate(s) which precludes the possibility of discovering nonlinear changes in emission factors (EF, % of added N converted to N₂O-N) with increasing fertilizer-N rates.

To examine the relationship between N rates and N₂O fluxes in a tropical region, we compared farming practices with three or four N rates for their yield-scaled impacts from three crops in peninsular India. We measured N₂O fluxes during nine seasons between 2012 and 2015, with N application rates ranging between 0 and 70, 0 and 90, and 0 and 480 kg-N ha⁻¹ for foxtail-millet (*Setaria italica* L., locally called korra), groundnut (*Arachis hypogaea* L., also called peanut) and finger-millet (*Eleusine coracana* L., locally called ragi), respectively. In two cases, the highest N application rate greatly exceeded crop-N needs. Despite 65-80% lower total N application rates, the Low-N alternative practices led to statistically similar or higher yields when compared with High-N business-as-usual treatments. If average yields from these two treatments are compared, Low-N treatment yields were found to be 25-35% higher than those from High-N treatments in many cases because of the addition of more organic matter and/or other nutrients. Potential climate smart farming agricultural practices (with low/optimized N rates) led to a 50-150% reduction in N₂O emissions intensity (per unit yield) along with a reduction of 0.2-0.75 tCO₂e ha⁻¹ season⁻¹ as compared to high N conventional applications.

We found a non-linear increase in N₂O flux in response to increasing applied N for both N-fixing and non N-fixing crops and the extent of super-linearity for non N-fixing crops was much higher than what has been reported earlier. If a linear fit is imposed on our datasets, the emission factors (EFs) for finger-millet and groundnut were ~3.5% and ~1.8%, respectively. Our data shows that for low-N tropical cropping systems, even when they have low soil carbon content, increase in N use to levels just above crop needs to enhance productivity might lead to relatively small increase in N₂O emissions as compared to the impact of equivalent changes in fertilizer-N use in systems fertilized far beyond crop N needs.

Keywords

Nitrous oxide; India; Agricultural climate mitigation; Sustainable farming; Climate smart farming; Non-linear emission factors; Nitrogen surplus; Peanut; Groundnut; Millet; Finger-millet; Foxtail-millet

Acknowledgments

We thank finger-millet farmers Surendra N.R. (2012-2014), Hanumanthaiya (2015) and groundnut farmer Nagendra Reddy for their constant cooperation. We are grateful to the members of the Low Carbon Farming (LCF) research team who served as leading laboratory research personnel during this project and collected and analyzed all samples. We also acknowledge Fair Climate Network's Dr. Malla Reddy, C.K. Ganguly, Mary Philomena, Dr. Yellamanda Reddy, Shiekhshah Vali, Naveen Kumar, Dr. Sudha Padmanabha and Tashina Esteves for their critical support and advice.

Datasets

Supporting datasets associated with this report (Tables S1 to S13) are available on the Dryad portal at the persistent identifier: <https://doi.org/10.5061/dryad.cfxpvnvx5r>

Contents

Introduction	10
Materials and Methods	11
Soil characteristics and weather conditions	12
<i>Fig 1. Agro-ecological regions</i>	13
Treatments.....	14
N ₂ O flux monitoring.....	17
<i>Fig 2. Manual chamber design</i>	18
Crop yield, yield scaled GHG flux and N mineralization rates	18
Results	19
Crop yields	19
Nitrous oxide emissions.....	20
<i>Fig 3. N₂O variation within replicate treatments.</i>	20
<i>Fig 4. N₂O variation across treatments.</i>	21
<i>Fig 5. N₂O response for N-fixing groundnut.</i>	21
<i>Fig 6. N₂O response for millets.</i>	22
Fallow periods and negative emissions	22
Economics	23
Discussion	23
Multivariate linear regression models.....	24
<i>Fig 7. Non-linear N₂O emissions response curves:</i>	24
Comparison of wet and dry sites	25
N-fixing vs non N-fixing crops.....	26
Mitigation potential.....	26
Emission factors	26
Implications	27
Differential impacts of low vs high N input upland crops	27
Market mechanisms for promotion of sustainable practices.....	27
References	29
Supporting information	33
Supporting text	33
Introduction	33
Importance of regional studies to determine emission factors	33

Methods	34
Location of farms	34
Low N treatments	35
High N treatment for finger-millet (ragi).....	35
High N treatments for groundnut and foxtail-millet	36
Inter-cropping	37
Tillage/ploughing	37
Mineralization rates	37
Multiple regression models.....	38
Discussion and implications	41
Inefficient fertilizer use in India	41
Importance of high intensity sampling.....	41
Importance of involvement of local stakeholders and farmers.....	42
<i>S1 Fig. Impact of rainfall on yields during three foxtail-millet cropping seasons:</i>	<i>43</i>
<i>S2 Fig. High N₂O flux in fallow period after foxtail-millet growing season.....</i>	<i>44</i>
<i>S3 Fig. Average N₂O flux (with ± SE) for finger-millet for high rainfall site in 2015.....</i>	<i>45</i>
<i>S4 Fig. Average N₂O flux (with ± SE) for finger-millet for low rainfall site (2012-2014)...</i>	<i>46</i>
<i>S5 Fig. Average N₂O flux (with ± SE) for foxtail-millet in 2014</i>	<i>48</i>
<i>S6 Fig. Average N₂O flux (with ± SE) for groundnut in kharif (2012-2014).....</i>	<i>49</i>
<i>S7 Fig. Average N₂O flux (with ± SE) for groundnut in rabi (irrigated season) 2012.....</i>	<i>51</i>
<i>S8 Fig. Frequency distribution graphs of N₂O flux for different replicate finger-millet replicate plots in 2015.</i>	<i>52</i>
<i>S9 Fig. Frequency distribution graphs of N₂O flux for different replicate finger-millet replicate plots in 2012-2014</i>	<i>53</i>
<i>S10 Fig. Frequency distribution graphs of N₂O flux for different replicate foxtail-millet plots in 2014</i>	<i>55</i>
<i>S11 Fig. Frequency distribution graphs of N₂O flux for different replicate groundnut plots in groundnut (Kharif 2012-2014)</i>	<i>56</i>
Supporting datasets/tables	59
Supporting references.....	60

Non-linear reduction in nitrous oxide emissions through alternate management of groundnut and millets

Introduction

The climate crisis is very likely to fundamentally alter the structure of food systems around the globe (1, 2). With about 43% of the world's population employed in agriculture, and given that agriculture and associated land use change account for a quarter of total global greenhouse gas (GHG) emissions (3), it's vital that farmers have the knowledge and tools both to mitigate and to adapt to climate change.

The climate impacts of upland crops are primarily due to emissions of nitrous oxide (N_2O), a potent greenhouse gas (4). The atmospheric concentration of N_2O , the third most important greenhouse gas after carbon dioxide (CO_2) and methane (CH_4) in terms of the effect on net radiative forcing globally (5), have been rising exponentially in the past 150 years. Emissions from agricultural soils account for 50% of the total global anthropogenic flux of N_2O (6) and most of it can be attributed to the use of N fertilizers which trigger microbial processes of nitrification/denitrification (4, 7-9).

Agricultural N_2O emissions are a subject of international discussion within the United Nations Framework Convention on Climate Change (UNFCCC). Accurate N_2O emission factors (EF) across agricultural systems are urgently needed from developing countries to improve current and future estimations of global agricultural GHG emissions (10). It is important to understand how N_2O emissions vary with changing N application rates because N-fertilizer rates applied by smallholder farmers in developing countries in tropical regions of the world vary a great deal for a given crop within a given agro-ecological zone. Observations in temperate regions of the world suggest that N_2O emissions accelerate with increased N application (11-13). This "superlinear" (i.e., faster than linear) response is likely due to the relatively greater excess N unused by the crops at higher fertilization levels; this residual soil N is available to be lost or emitted in multiple forms including as N_2O (11, 13-17). For N_2O , this superlinearity could be partially due to an increase in $N_2O:N_2$ ratio because of inhibition of nitrous oxide reductase at higher rates of N addition (18). The rate of increase in N_2O emissions as a function of increasing N inputs has been found to be faster in soils with higher (>1.5 %) soil organic carbon levels (13).

Overall, reduced uncertainty associated with non-linear N₂O emissions models compared to linear models is clearly supported in the literature for temperate soils (12, 13, 19). However, there are very few relevant studies on the applicability of non-linear responses to tropical and subtropical regions of the world (10). A recent study from Sri Lanka (20) claims that non-linear responses might not be applicable because low C availability in tropical soils limits N₂O emissions at high N inputs. However, an in-depth analysis from Mexico (16) in the regions with less than 0.83% organic matter (i.e., <0.48% soil C) (21) supports non-linear response of N₂O to increasing N rates. India is a major contributor to the recent growth in agricultural N₂O emissions that now exceed some of the highest projected global GHG emission scenarios (6) but no available datasets confirm or refute if non-linear N₂O response to N rates is applicable to Indian tropical soils.

Here, we have examined the relationship between changing fertilizer-N rates and N₂O fluxes in peninsular India for three drought resistant upland crops: groundnut, finger-millet and foxtail millet. In addition to their drought resistance, these three crops are important for semi-arid tropical regions of the world because of their low water and fertilizer requirements, their stability during storage and their nutritional value (22-24). India is the largest producer of millets in the world and second only to China in the production of groundnut (25). For detailed information on production statistics, area under and nutritional importance of each of these crops in India, please see supporting text.

We hypothesized that N₂O emissions from upland crops will be a function of water and N input with non-linear increase in N₂O with increasing N application rates. We also hypothesized that, as compared to conventional practices, carefully chosen alternate farming practice treatments including (but not limited to) lower N application rates that are close to crop-N requirements can deliver the three-fold goals of climate-smart farming i.e., 1) similar or higher yields 2) higher incomes; and 3) reduction of greenhouse gases emissions (1). This paper presents N₂O emissions data along with empirical equations of regional emission factors (EFs) for predicting direct N₂O emissions, yield and farm-level economic data from groundnut, finger-, and foxtail-millet grown at farmer-managed farms over a total of nine cropping seasons in peninsular India.

Materials and Methods

The five study farms (Fig 1) were selected in the Indian states of Karnataka and Andhra Pradesh, the largest producers of the groundnut and millet crops in India and the largest

consumers of fertilizers both with respect to total consumption in the state and per unit area (26). These two states are also heavily dependent upon monsoons (27) but have been facing very frequent droughts in the past decade. The measurement of GHG emissions, yield and other agro-economic indicators was performed for a total of nine seasons at three regional laboratories established by a coalition of partners interested in promoting climate smart farming in agro-ecological regions 8.2 and 3.0 (28) of the semi-arid peninsula of India (Figure 1).

Supporting datasets associated with this report (Tables S1 to S13) are available on the Dryad portal at the persistent identifier: <https://doi.org/10.5061/dryad.cfxpnvx5r>

Soil characteristics and weather conditions

Each of the five experimental sites was a farmer owned and managed small-holder plot and was located in peninsular India between 12.77-14.66 N (Latitude), 77.20-77.75 E (Longitude) and 350-790 m (elevation above sea level) (Figure 1). The experimental sites had sandy-loam and loamy-sand texture (680-750 g kg⁻¹ Sand, 120-170 g kg⁻¹ Silt and 130-170 g kg⁻¹ Clay) and soil organic matter concentration varying between 3.2 and 14.3 g kg⁻¹ (i.e., between 1.9 and 8.3 g kg⁻¹ soil C). Except in the case of foxtail millet (which was a newly cultivated site), the groundnut and finger millet plots were under continuous groundnut or finger-millet systems, respectively, for over a decade before establishment of our experiments. The soil characteristics of each site are given in S1 Table.

The climate of all study locations was semi-arid with measured seasonal rainfall varying from 56-480 mm during the experimental period. The lowest and the highest temperatures observed at our sites varied from 10-21 and 33-40 °C, respectively (see S1 Table for details of each site). All experimental sites were between 0.1 and 0.42 ha in size and the experimental treatments were implemented by the farmer under supervision of a trained field and laboratory research team. There were three replicates for each treatment and each subplot received one treatment with stratified randomized block design.

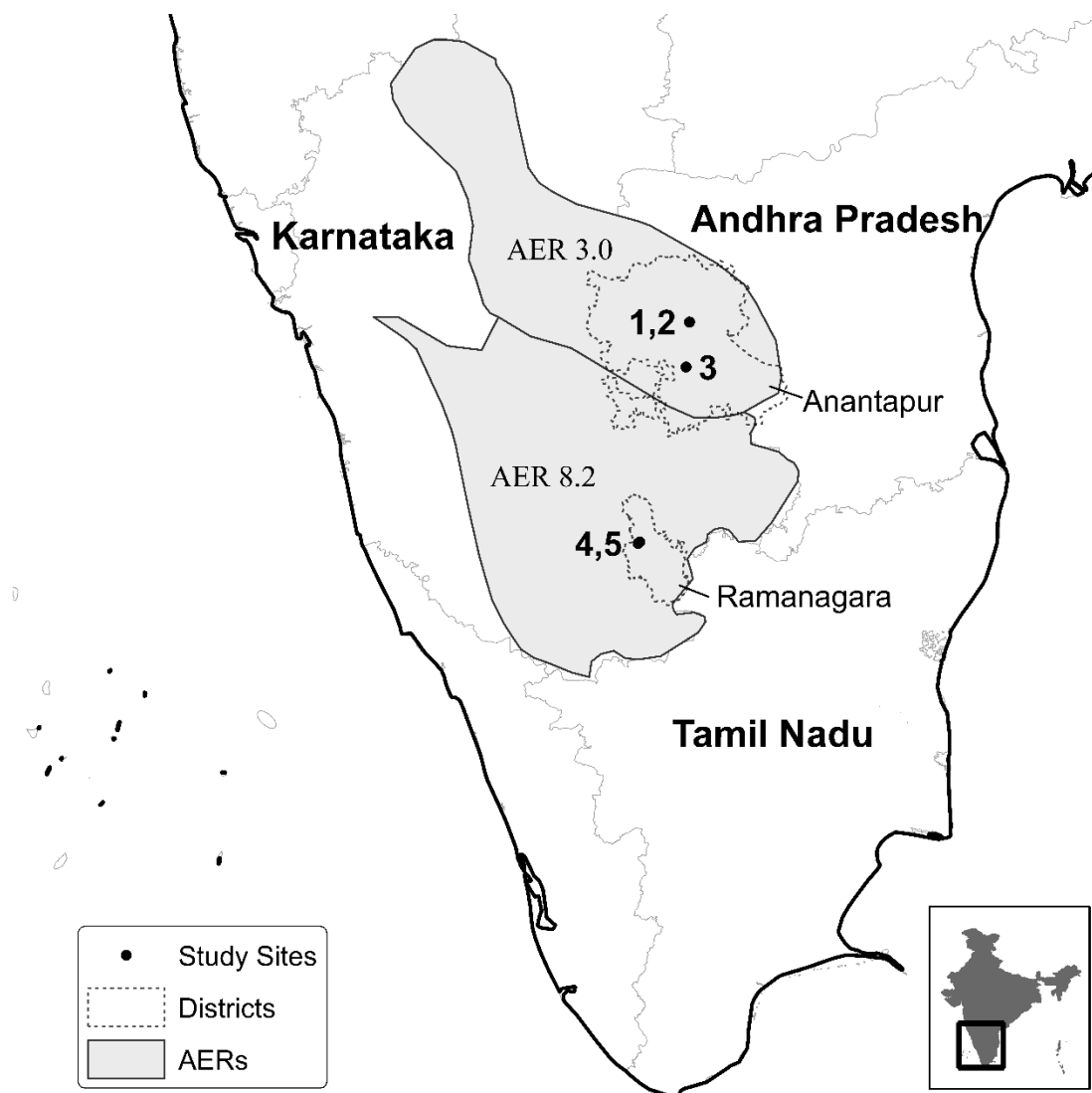

Fig 1. Agro-ecological regions

Agro-ecological region 3.0 includes portions of several districts in the state of Karnataka, as well as the Anantapur district in the state of Andhra Pradesh. Agro-ecological region 8.2 is mostly in the state of Karnataka. Groundnut was grown at study site 1 during kharif (Southwest monsoon season between July and December) and rabi (irrigated season between January and May) seasons in 2012 and at study site 2 during 2013 and 2014. Foxtail-millet was grown at study site 3. Finger-millet was grown at study sites 4 and 5.

Nitrous oxide emissions were measured for both finger-millet and groundnut during four cropping seasons each, along with some fallow periods flanking these growing seasons between July 2012 and December 2015. Groundnut was sown between July 10-September 4 and harvested between November 3-December 25. Finger-millet was sown between August 3-August 25 and harvested between November 25-January 1. Due to severe drought and other complications, N_2O emissions data from the foxtail-millet farm could be collected only for one season between October 12, 2014 and January 19, 2015. The data from two groundnut growing seasons (dry *kharif*

and irrigated *rabi* in 2012) was published earlier (29) and is presented here with new estimates of mineralized organic nitrogen which impacted the calculation of EFs (see SI section on mineralization). During the fallow periods, there were no inputs of water or fertilizer to the experimental sites, except to prepare for the upcoming cropping season.

Treatments

We compared N₂O emissions from three or four broad categories of treatments: Very-high-N (VHN, conventional practices with N rates varying from 91 to 276 kg N ha⁻¹), High-N (HN, conventional practices identified via our local farmer surveys with total N rate varying from 53 to 248 kg N ha⁻¹; see S3 Table for farmer survey results), Low-N (LN, farm-specific potential climate-smart farming practices including completely organic practices for groundnut farms, total N varying from 17-78 kg N ha⁻¹) and a zero N (control). We explored changes in N₂O emissions with changing N fertilizer inputs under scenarios where water input was either below or above water requirements for groundnut (>280 mm) (30) and finger-millet (>450 mm)(31). The dry sites for groundnut had water input between 100-200 mm in the rainfed season (locally called *khariif*) whereas the wet site had a water input of 370 mm (irrigated winter season locally called *rabi*). The dry and wet rainfed sites for finger-millet had water inputs between 100-350 mm and ~480 mm, respectively.

The Low-N treatment (Table 1 and S3-S4 Tables) represented farm-specific “alternate” practices that were investigated for their potential to deliver similar (or higher) yields and economic benefits to farmers as well as lower climate impacts (29, 32). The potential climate-smart farming practices investigated for foxtail-millet and groundnut farms in agro-ecological region (AER) 3.0 involved completely organic (with no synthetic) inputs.

Except in the case of finger-millet, the High-N treatment represents the conventional “business-as-usual” crop management practices as currently implemented by farmers with average to large land-holdings in this region. As explained earlier (29, 32), the conventional practices were identified via regional farmer surveys conducted during the study. The recommended inorganic N use for groundnut, finger- and foxtail- millet is 20-30 (29), 50 (33), and 30 (34) kg N ha⁻¹, respectively. Farmer surveys conducted during this study or by the Indian government indicated that farmers were using much higher fertilizer N application rates than the crop-specific recommendations by the state/district governments and/or academic institutions. Please see S3 Table for comparison of survey results with “High N” treatments.

The Very-High-N treatments for finger-millet and groundnut included addition of nitrogen fertilizers much higher than the respective crop’s nitrogen needs. These treatments were

included specifically to test the extent of super-linear response in N₂O emissions when N inputs are very high.

Overall, the N fertilization rates for groundnut, finger-millet and foxtail millet varied from 0 to 77, 0 to 470 and 0 to 49 kg N ha⁻¹, respectively. The rate and timing of all organic and inorganic fertilizer applications are provided in S2 Table and total N rate (including contribution from mineralized organic N) for each treatment is presented in Table 1.

In general, the soils in the two agro-ecological regions are not amenable to cultivation without ploughing. For groundnut and foxtail-millet, tillage was done once in each season about 25 days before sowing. For finger-millet, tillage was done 2-4 times between March and July soon after rainfall depending on soil hardness and manure (if any) was incorporated during the last 1-2 tillage events. Bullock cart ploughing tills soil to a depth of 12 cm and local tractors (used only when the soil is very hard) plough to the depth of up to 18 cm. There was no tillage done to control weeds and there was no use of herbicides and pesticides.

During the rainfed south-west monsoon season (from July to December; locally called *kharif*), sowing was done manually at a seed rate 146 ± 27 kg ha⁻¹ for groundnut (Kadiri 6 variety) at a 30 cm row spacing, 10 cm plant spacing and to a depth of 5 cm, 12 kg ha⁻¹ for foxtail millet (local variety called Jadda Korra) at a 30 cm row spacing, 8-12 cm plant spacing and to a depth of 3-6 cm and 24.7 kg ha⁻¹ for finger-millet (MR1 variety) at a 25 row spacing to a depth of 3-6 cm. Both millets are sown with a seed drill attached to a bullock and the plots are thinned/weeded 12-20 and 20-25 days after sowing of finger- and foxtail-millet, respectively. The seed rates used in a given crop and season were the same for all treatments. All of the aboveground biomass (as well as belowground biomass for groundnut) was harvested manually 110-130 days after sowing (see exact dates in S1 Table).

Table 1: Crop management practices, climate impacts and farm economics

Treatment	(Min - Max)		Total N (kg ha ⁻¹)	Grain yield ² (kg ha ⁻¹)	N ₂ O flux (kg N ₂ O-N ha ⁻¹)	GHGI (Flux/yield) (tCO ₂ e t ⁻¹)	Total cost (Rs ha ⁻¹) ³	Revenue (Rs ha ⁻¹) ³
	Inorganic N (kg ha ⁻¹)	Organic N ¹ (kg ha ⁻¹)						
Finger-millet ² (Dry low rainfall site: 205 ± 120 mm) 2012-14								
Very High N	470	3 - 9	476 ± 3	1135 ± 156 ^a	15.47 ± 2.75 ^a	6.38 ± 1.25		
High N	206	3 - 10	213 ± 3	1469 ± 105 ^a	1.94 ± 0.55 ^b	0.62 ± 0.18	21913 ± 107	35815 ± 1209
Low N (SA)	50	14 - 42	78 ± 14	1284 ± 248 ^a	0.34 ± 0.08 ^c	0.13 ± 0.03	21635 ± 634	32361 ± 1370
Control	0	0 - 0	0 ± 0	623 ± 17 ^b	0.27 ± 0.05 ^c	0.20 ± 0.04		
Finger-millet ² (Wet high rainfall site: 480 mm) 2015								
Very High N	463	5 - 14	473 ± 5	2095 ± 452 ^a	18.01 ± 6.48 ^a	4.03 ± 1.69		
High N	238	5 - 14	248 ± 5	2307 ± 178 ^a	8.08 ± 0.63 ^{ab}	1.64 ± 0.18	29251 ± 0	59908 ± 1514
Low N (SA)	41	5 - 14	50 ± 5	2929 ± 338 ^b	1.27 ± 0.03 ^{ac}	0.20 ± 0.02	18574 ± 0	75356 ± 2771
Control	0	0 - 0	0 ± 0	1869 ± 197 ^a	0.33 ± 0.22 ^{ac}	0.08 ± 0.06		
Foxtail-millet ² (Dry rainfed: 56 mm) 2014								
High N	49	10 - 32	70 ± 11	208 ± 19 ^a	0.30 ± 0.09 ^a	0.7 ± 0.20	15601 ± 0	7717 ± 0
Low N (SA)	0	8 - 26	17 ± 9	140 ± 18 ^a	-0.10 ± 0.16 ^b	-0.3 ± 0.08	13865 ± 0	8060 ± 0
Control	0	0 - 0	0 ± 0	26* ± 0 ^b	-0.2 ± 0.00 ^b	-1.3 ± 0.20		
Groundnut ⁴ (Dry rainfed site: 163 ± 17 mm rain) 2012-14								
Very High N	77	7 - 22	91 ± 8	240 ± 0	2.43 ± 0.43 ^a	4.73 ± 0.83		
High N	37±9 [#]	7 - 25	53 ± 9	376 ± 53 ^a	1.17 ± 0.11 ^b	1.45 ± 0.16	42277 ± 659	30131 ± 2129
Low N (SA)	0	7 - 29	18 ± 11	514 ± 94 ^a	0.83 ± 0.09 ^c	0.75 ± 0.11	38682 ± 644	39781 ± 4628
Control	0	0 - 0	0 ± 0	254 ± 0	0.49 ± 0.03 ^d	0.90 ± 0.05		
Groundnut ⁴ (Wet site: 370 mm water use) 2012								
High N	75	8 - 23	90 ± 8	1021 ± 0	1.89 ± 0.21 ^a	0.87 ± 0.10	51678 ± 0	89419 ± 0
Low N (SA)	0	10 - 30	20 ± 10	1379 ± 0	1.38 ± 0.26 ^a	0.47 ± 0.09	47572 ± 0	111008 ± 0

All uncertainties are 1 SE. For each of the five categories, different superscript letters (a-d) next to yield and N₂O flux columns denote statistical difference (p < 0.1). p values are lower than 0.01 in several cases. Statistical difference between two groups could be calculated only when individual values of parameters in the two groups were available. ¹ Nitrogen from organic sources. The column presents an estimate of mineralised organic N available during the season (See SI Tables 4.1-5.5). ² Row area correction done for both millets such that intercrop and border crop yields are not included here. ³ Please see SI Tables 7.1-9.3 for details. These entries represent our preliminary assessments and need to be verified by future studies that include multiple farmers. Foxtail-millet and groundnut cropping seasons had poorer rainfall than is necessary for optimum production (~300 mm) and sometimes net income (Revenue - Total cost) was negative. ⁴ With the exception of new calculations of mineralized and total N, data from the year 2012 is from Kritee et al (2015). #Variations existed from year to year because farmers change the amounts of fertilizer added in response to rainfall *See SI Figure 2. Resowing was not done in the control sub-plots. See main text.

N₂O flux monitoring

Manual closed chambers were used to collect air samples from each of the three replicate treatment plots and the air samples were analyzed by electron capture detector (ECD) in a gas chromatograph (Thermo Fisher Trace GC 600) to quantify N₂O emissions rates based on methodology developed in our labs (29, 35). Because most N₂O emissions occur within 1-4 days following N addition and/or irrigation/rainfall (36), N₂O flux measurements are more reliable when the sampling frequency is high and the sampling schedule captures spatio-temporal variability in emissions (37). We performed sampling on 34-60% of the total days in each season (S1 Table), with continuous sampling for 3-5 days after all “events” e.g. sowing, fertilizer application, irrigation/rainfall and weeding with an average of three measurements every week. Stackable manual chambers (size: 30*30*40 cm) were deployed on base-frames. A second 30cm*30cm*40cm chamber was stacked on top of the first chamber if (and only when) the plant height exceeded 40 cm (Fig 2). On each sampling day, four air samples (60 ml each) were collected at 10 minute intervals for 30 minutes between 10 AM and 12 noon to calculate the hourly N₂O flux. The GC was calibrated daily with four standards: 0.197, 0.393, 0.795 and 1.615 ppmv N₂O (Bhuruka Gases, Bengaluru; NIST certified at 2% RSD).

For chamber deployment period of half hour, four sampling points under linear regression, minimum detectable N₂O flux was 33.8 ppb (38, 39) which translates into ~20µg m⁻² h⁻¹ for our chambers with a volume of ~36L, ambient temperatures in the range of 35-45 °C and baseframe footprint of 0.09m². Following the recommendation of Parkin and Venterea (2010), we used the actual measured value even if it falls below the minimum detection limit (MDL). The details of the design of chambers and base-frames, methods employed to achieve uniform mixing of headspace air, chamber volume and temperature corrections, sample storage, data analysis, treatment of negative emissions, calculation of seasonal fluxes and curve fitting have been described previously (35). Cumulative emissions were calculated separately for each replicate plot before calculating the average emissions for each treatment. For a given farm, when available, the results from different years were averaged for treatments with similar N input rates (Table 1 and S2 Table) to perform multiple regression. The cumulative N₂O flux during a cropping season was calculated by linear interpolation as explained earlier (35).

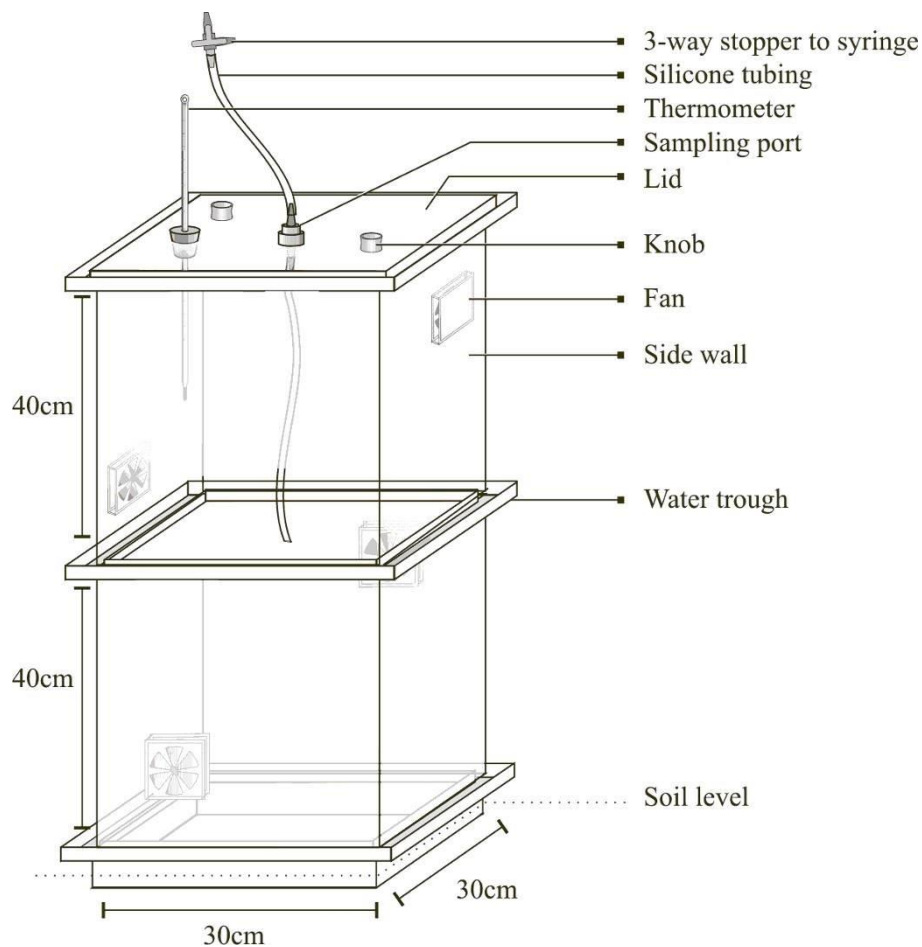

Fig 2. Manual chamber design

Two stacked manual chambers with detachable lid were used for finger-millet and foxtail-millet after the crop height became close to 40 cm.

Crop yield, yield scaled GHG flux and N mineralization rates

Yields were measured from each treatment at maturity at the end of a season after separating groundnut pods or millet grains from the plant/straw and sun drying to a constant weight. It is customary in this region to use crop residue to feed cattle and not return it to the plots. Yield scaled GHG flux (i.e., GHGI) for each treatment was calculated by converting average N_2O flux into CO_2e after multiplying by 298 (Global warming potential of N_2O) (40) and dividing by average yield for that treatment. The errors (SE) associated with GHGI were calculated by standard error propagation method. Mineralization rates for the applied organic nitrogen were estimated using methods described earlier (32). Please refer to the supporting file for more details.

Statistical and multiple regression analysis

Unless mentioned otherwise, all errors represent one standard error (SE) and were propagated during addition, subtraction or multiplication. In order to estimate the significance of differences between means of yield and N₂O emissions, two-tailed standard T-tests ($p < 0.1$) were performed (Table 1). Standard errors and statistical differences between means of variables (e.g., Yields, N₂O flux, GHGI) could be determined only when values of individual replicates were available.

The purpose of the multiple regression modeling was to confirm if N₂O emissions increase non-linearly with N fertilization rate. Our study was not designed to study influence of additional parameters (e.g., rainfall, SOM, seed rate etc) but we did explore the correlations among the N₂O emissions and parameters available for each crop using the same multiple regression modeling approach and show the performance of the alternative models with minimum AIC values in the supporting text. Each millet or groundnut farm with a different treatment was considered an independent observation in the multiple regression analysis. To select our multivariate regression model(s) for N₂O, we consecutively added/removed parameters like rainfall, amounts of organic and inorganic N, soil pH and organic content looking to minimize the Akaike Information Criterion (AIC) and checking for model significance after adding or removing parameters. S9-S10 Tables present the detailed dataset used for the regression analysis. Significance of some parameters (e.g., total nitrogen use, soil texture or SOM) were checked as continuous predictors, others (e.g., high rain vs low rain or millet-type) was checked both as categorical predictors. We did not expect that the year of the sampling will play a significant role in our results and the addition of year as a categorical parameter was not statistically significant ($p < 0.05$) for millets or groundnut.

For comparison with IPCC global average and Indian EFs for upland crops, emission factors for groundnut and millets were calculated by doing linear regressions on N₂O-N and N_{total} values (as shown in S10-11 Tables). These linear regressions always explained much lesser variance (i.e., had lower R²) than quadratic equations obtained via multiple regression analysis.

Results

Crop yields

Despite 63-80% lower total N application rates (Table 1), the Low-N sustainable farming practices led to statistically similar dry grain yields when compared with High-N conventional

treatments. If one compares average yields from the two treatments, Low-N treatment dry grain yields were 25-35% higher than those from High-N treatments in all cases, except finger-millet dry sites and foxtail-millet cropping season (Table 1). Yields at our foxtail-millet farm in 2014 for all treatments were exceptionally low because of very low rainfall (see S1 Fig).

Nitrous oxide emissions

Because of lower N surplus ($N_{\text{fertilizer-inputs}}$ minus $N_{\text{crop-output}}$), N_2O emissions per unit sown area and yield were significantly lower for Low-N treatments as compared with High-N or Very-High-N treatments (Table 1). Typical temporal changes in N_2O fluxes show spatial variation within replicate plots (Fig 3) and clear impacts of different treatment (i.e. different N rates) on total N_2O emissions (Fig 4 and Table 1). As expected, daily N_2O fluxes vary with the timing of the addition of chemical fertilizers and rainfall. Seasonal N_2O fluxes and the intensity of N_2O emissions per unit yield responded to changes in N fertilization rates (Table 1) for both groundnut (Fig 5; Equation 1) and millets (Fig 6; Equation 2). Average seasonal cumulative emissions for different treatments are presented in Table 1. For all crops, Low-N treatments (potential climate smart practice package) had lower N_2O emissions than High-N treatments (conventional practice packages for groundnut and foxtail-millet, see supporting text) in all seasons.

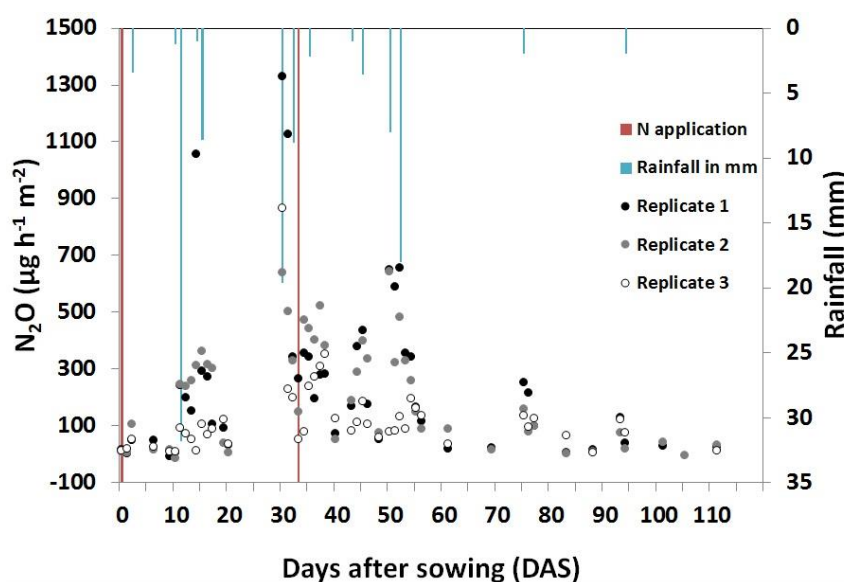

Fig 3. N_2O variation within replicate treatments.

This figure shows N_2O fluxes recorded at three very high N replicate treatments with the same nitrogen fertilizer input at a groundnut farm in kharif 2014. Red lines represent timing of the addition of N fertilizers. Blue lines represent rainfall recorded in the weather station next to the farm.

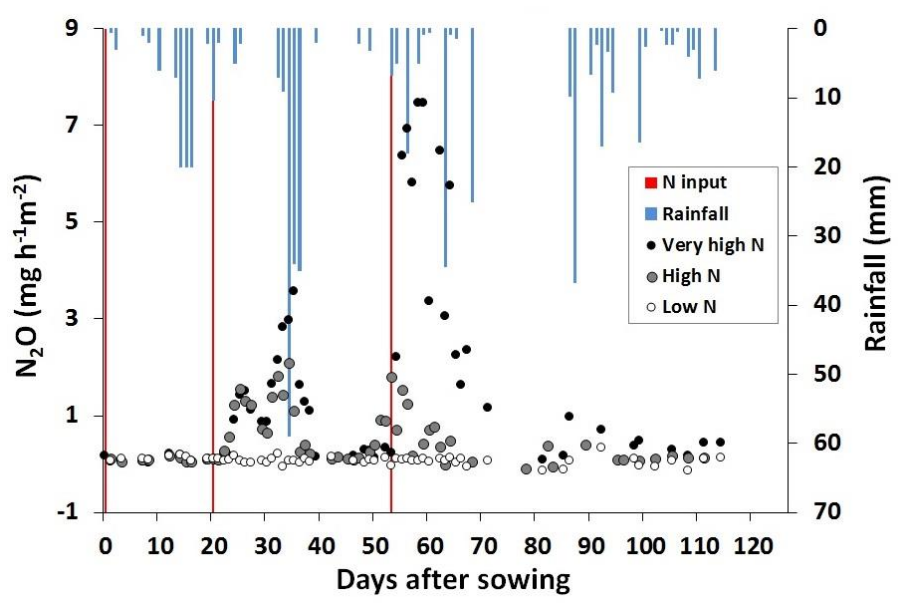

Fig 4. N₂O variation across treatments.

This figure shows N₂O fluxes under different N fertilization rates at a finger-millet farm in 2015 at a high precipitation site. Red lines represent timing of the addition of N fertilizers. Blue lines represent rainfall recorded in the weather station next to the farm.

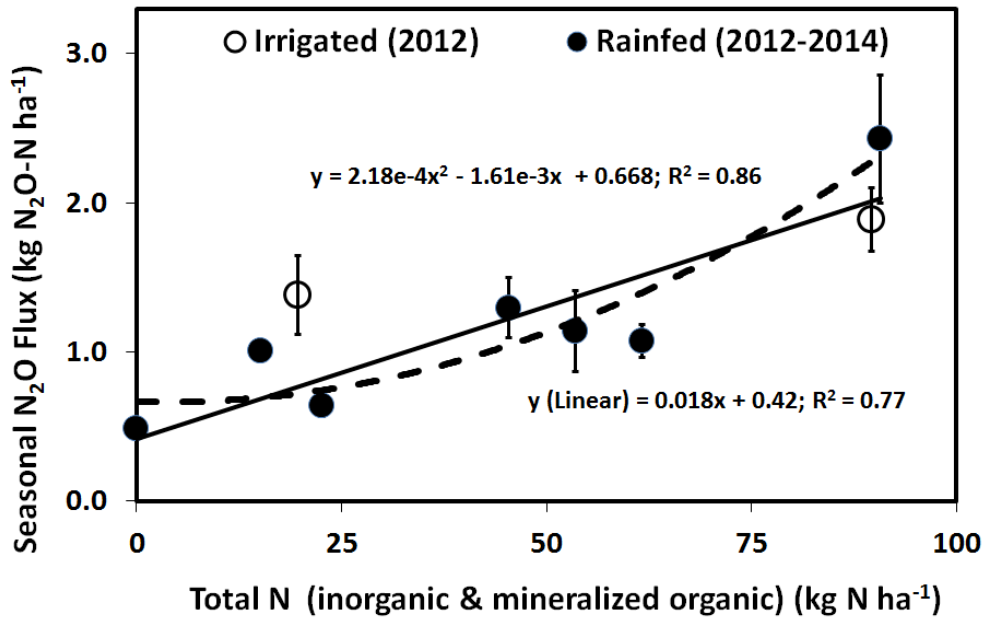

Fig 5. N₂O response for N-fixing groundnut.

This figure shows both the non-linear and forced linear response of N₂O to changing N_{total} rate for groundnut (a N-fixer). The plotted data corresponds to data from individual years. The two data points corresponding to irrigated season are not included in the two regressions equations which are based on independent observations from individual rainfed (kharif) cropping seasons.

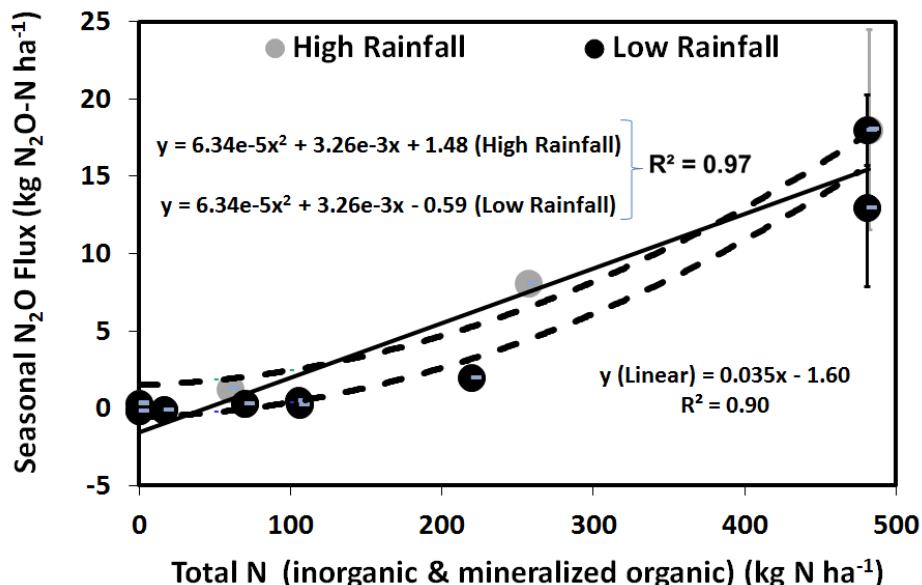

Fig 6. N₂O response for millets.

This figure shows both the non-linear and forced linear response of N₂O to changing N_{total} rate for foxtail- and finger-millet which are non N-fixing upland crops. The plotted data corresponds to data from individual years. The regression equations are based on independent observations from individual finger- and foxtail-millet cropping seasons.

A maximum hourly N₂O emissions of ~1350, ~7500 and ~250 $\mu\text{g N}_2\text{O-N m}^{-2} \text{ h}^{-1}$ was recorded for a Very-High-N replicate treatment for groundnut (Fig 3), a Very-High-N replicate treatment for finger-millet (Fig 4) and High-N replicate treatment for foxtail-millet (S2 Fig), respectively. Average N₂O fluxes (with SE) for different treatments and seasons are presented in S3-S7 Figs. As expected and shown previously (Kritee et al, 2015), the N₂O data were not log normally distributed (S8-S12 Figs.) Crucially, the average N₂O emissions per unit yield for Low-N treatments was 50-150% less than High-N treatments (Table 1).

There were minimal N₂O emissions after addition of organic amendment (i.e., FYM) before sowing in all cropping seasons. The first set of synthetic fertilizers were applied on the day of sowing (0 DAS) and even meager rainfall of ~3.5 mm on 3 DAS (Fig 3) led N₂O emissions to increase to ~100 $\mu\text{g N}_2\text{O-N m}^{-2} \text{ h}^{-1}$. In general, the N₂O emissions were routinely found to be higher within 1-3 days of substantial rain events relative to dry periods and were the highest when N addition coincided with rain events. As expected, the finger-millet (2015) and groundnut (Irrigated, 2012) seasons gave comparatively higher emissions than 2012-2014 finger-millet or groundnut (rainfed, 2012-2014) because of greater water availability (Table 1), especially for Low N rates.

Fallow periods and negative emissions

Below MDL N₂O and negative fluxes were measured between 4 to 47% and 5 to 38% of the total number of days in a cropping season, respectively (S1 Table). Negative flux rate as low as ~

-112 $\mu\text{g N}_2\text{O-N m}^{-2} \text{ h}^{-1}$ was observed (S6 Table) which was significantly larger than MDL of our study ($<20 \mu\text{g N}_2\text{O-N m}^{-2} \text{ h}^{-1}$). As reported earlier (29), small but significant negative N_2O emissions rates were apparent both under wet (0-2 days after rainfall events) as well under dry (5-12 days after rainfall) conditions (S6 Table). The likely reasons for negative N_2O emissions include the conversion of N_2O to N_2 (complete denitrification) (29).

Emissions during the fallow periods generally remained negative or low (-0.005 to 0.025 $\text{kg-N}_2\text{O ha}^{-1} \text{ day}^{-1}$). However, there was a striking positive impact of rain events in the fallow periods for HN or VHN plots with a maximum of ~ 2600 and $\sim 725 \mu\text{g N}_2\text{O-N m}^{-2} \text{ h}^{-1}$ from finger-millet subplots during the post-2012 and post-2013 *kharif* fallow, respectively; and $\sim 340 \mu\text{g N}_2\text{O-N m}^{-2} \text{ h}^{-1}$ for foxtail-millet (post 2014 harvest) (See S2 Fig and S12 Table). Because the fallow period flux rates are generally very low and we do not have data for the entire length of the fallow periods and/or for all the fallow periods, we have not included this data in the calculation of emission factors. There was no evidence of the effect of ploughing, inter-cultivation and weeding on N_2O flux rates.

Economics

Cost of cultivation (including input cost of seeds, fertilizers, pest management and machinery as well as labor cost of sowing, weeding and harvesting) and revenue were computed at local market rates (see S7-S9 Tables) using a $\$1 = ₹65$. With the exception of finger-millet in the dry low rainfall region where the differences seem negligible, high nitrogen treatments had 10-55% higher cost of cultivation than low N treatments. Low N treatments also resulted in 5-25% higher revenue than high N treatments. More studies with multiple participating farmers are needed to confirm these results.

Discussion

While there have been no published studies documenting climate impacts of finger-millet and foxtail-millet cultivation, a few studies have looked at climate impacts of two other relatively common millets, Pearl-millet and Sorghum (41-43). In contrast, fertilizer-induced N_2O emissions have been documented to occur during cultivation of groundnut in India (29), Malaysia (44) and China (45). Neither the existing studies on millets and groundnut nor any of the recent Indian studies on other upland crops (e.g., wheat or maize) (46-48) have examined N_2O emissions at

more than two N rates precluding the possibility of examining non-linear response of N₂O to increasing N use.

Multivariate linear regression models

We expected the relationship of N₂O with total N use to change based on water input and therefore considered the data from wet and dry sites separately. Water requirement for groundnut and finger-millet is >280 mm (30) and >450 mm (31), respectively. Except for the irrigated groundnut season, strong quadratic relationships between seasonal N₂O-N and N_{total} are observed for groundnut and millets (Figs 5-6 and S10-S11 Tables). Most strikingly, these observed non-linear relationships are similar to relationships seen in meta-analysis by Shcherbak et al (2014) for N-fixing crops (Fig 7) such that for a given N application rate, N₂O emissions from groundnut were much higher than from the millets.

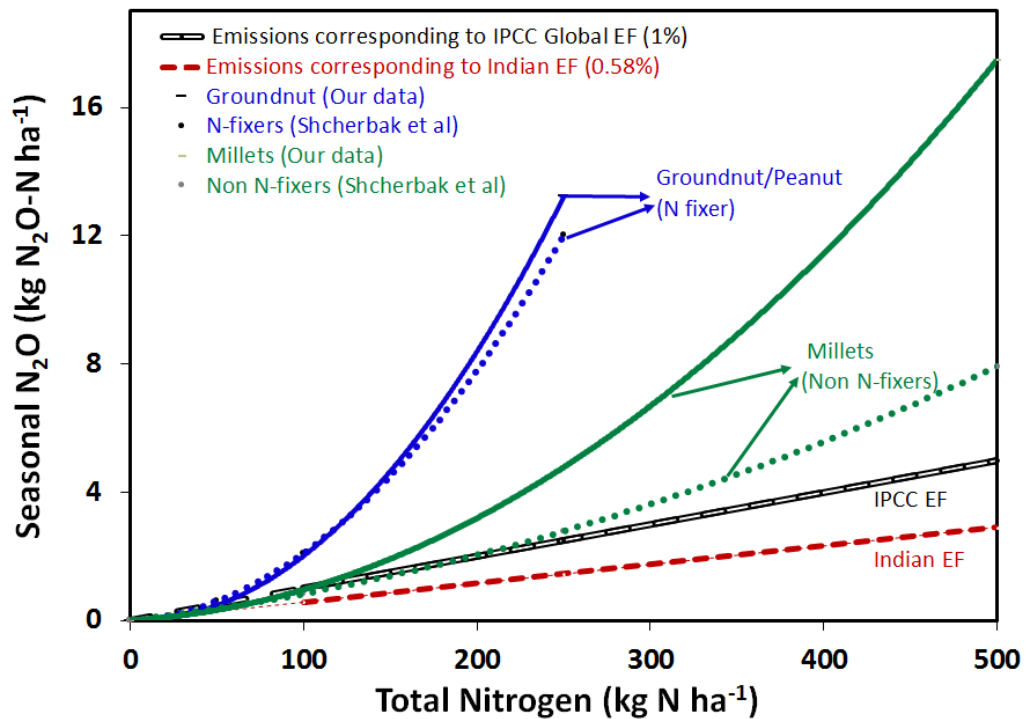

Fig 7. Non-linear N₂O emissions response curves:

This figure shows non-linear response of N₂O to changing N_{total} rate seen in our study for rainfed groundnut and millet cropping seasons. For comparison, the linear responses (corresponding to emission factors of 1% and 0.58% adopted by the IPCC and the Indian Government; N₂O-N = EF*100*N rate) and the non-linear response seen for seven N-fixing and over two hundred and twenty non N-fixing upland crops (13) are also presented. In our experimental data, average groundnut N input ranges from 0 to 91 kg N ha⁻¹ but this figure extrapolates that data up to 250 kg N ha⁻¹ for better comparison with regression equation for N-fixers from Shcherbak et al. Note that the intercepts have been made equal for easier comparison.

For Groundnut rainfed sites, the following equation best describes the N₂O response to changing N rates:

$$\text{N}_2\text{O-N (kg ha}^{-1}\text{)} = 2.18\text{e}^{-04}(\text{N}_{\text{total}})^2 - 1.61\text{e}^{-03}\text{N}_{\text{total}} + 0.668$$

$$(p < 0.02; \text{Multiple } R^2 = 0.86; \text{Adjusted } R^2 = 0.79) \quad \textbf{(Equation 1)}$$

For the two millets (i.e., non N-fixing upland crops), the following equations best describe N₂O emissions:

$$\text{N}_2\text{O-N (kg ha}^{-1}\text{)} = [6.34\text{e}^{-05} (\text{N}_{\text{total}})^2 + 3.26\text{e}^{-03} (\text{N}_{\text{total}}) - 0.59 \text{ (rainfall} < \text{Crop requirement)}$$

$$\text{N}_2\text{O-N (kg ha}^{-1}\text{)} = [6.34\text{e}^{-05} (\text{N}_{\text{total}})^2 + 3.26\text{e}^{-03} (\text{N}_{\text{total}}) + 1.48 \text{ (rainfall} > \text{Crop requirement)}$$

$$(p = 8.9\text{e}^{-08}; \text{Multiple } R^2 = 0.97; \text{Adjusted } R^2 = 0.96) \quad \textbf{(Equations 2-3)}$$

Here N₂O-N represents emissions in kg-N ha⁻¹ season-1 and N_{total} is the average total (inorganic + mineralized organic) N added in a season in kg ha⁻¹ (Table 1; S10-11 Tables). As explained earlier (32), the range of mineralization rates of organic N over three years was obtained from literature (See S4-S5 Tables). Please see supplementary text for more details about alternative multiple regression models. During multiple regression analysis of the datasets from two millets, the categorical term for millet type (foxtail vs. finger millet) was not statistically significant, supporting treating them as part of the same group.

Comparison of wet and dry sites

India has a system of rainfed agriculture: about 72% of 143 million hectares of net cropped area, is under rainfed production (27). Thus, it is crucial to understand how emission factors might differ between irrigated vs. rainfed sites or dry vs. wet rainfed sites.

For groundnut, we do not have a statistically significant number of datasets for irrigated groundnut to be able to systematically compare them with rainfed groundnut. However, it does appear that N₂O emissions from irrigated groundnut plots follow a different trajectory than rainfed groundnut plots (Fig 5). For finger-millet (Fig 6), on an average, wet rainfed site gave both higher yields and higher emissions at similar N application rates as compared to the dry rainfed site. While there isn't enough data in our study to elucidate the reasons for differences among sites, it is clear that higher rainfall increases N₂O emissions.

N-fixing vs non N-fixing crops

Our non-linear model (Equation 1) for groundnut-N₂O seems very similar to Shcherbak et al's N-fixing crop model ($y = 1.8e^{-4}x^2 + 3e^{-3}x + \text{constant}$, Fig 7). For non N-fixing crops, our model (Equation 2) appears to be significantly different from Shcherbak et al's model for non N-fixing upland crops at high N rates ($y = 1.9e^{-5}x^2 + 6.5e^{-3}x + \text{constant}$, Fig 7). Consistent with the N surplus approach, our model for millets clearly shows that as compared to non N-fixing upland crops, N-fixing crops have higher acceleration in EF with increasing N additions because of lower N fertilizer needs of N fixers (13).

Mitigation potential

Direct comparison of average N₂O emissions from Low-N (sustainable) and High-N (conventional) treatments suggests that the climate impact of Low-N treatments were ~0.2-0.4 tCO₂e ha⁻¹ lower for groundnut and foxtail-millet (Table 1).

For finger-millet, direct comparison of our Low-N and High N treatments for estimation of mitigation potential of sustainable treatments is not appropriate. We recommend the use of Indian government's survey based N rate of 150 kg N ha⁻¹ as the conventional N application rate for finger-millet when calculating climate mitigation benefits of sustainable practices instead of using the total nitrogen rate implied in our High-N treatments (213-248 kg N ha⁻¹; see supporting text). Use of our empirical model for finger-millet (Equation 2), 150 kg N ha⁻¹ as the conventional N rate used by business-as-usual farmers, and 40-50 kg N ha⁻¹ as the N rate used at low N use farms implies a mitigation of ~0.75 tCO₂e₁₀₀ ha⁻¹.

Emission factors

India's second national communication to The United Nations Framework Convention on Climate Change (UNFCCC) estimated emissions of N₂O from agricultural soils to be 155 Gg of N₂O (46.2 MtCO₂e) in 2007 (49) with inorganic fertilizers contributing about two thirds of these emissions. As a result of increasing fertilizer use, a linear increase in N₂O emissions between 1980 and 2007 has been estimated (50) because India uses linear EF of 0.58% (43). This Indian emission factor implies that there is a linear relationship between N application rate and N₂O emissions. In contrast, our data show a faster than linear N₂O emissions increase with increasing N inputs. To our knowledge, our work is the first body of work that measured N₂O emissions from up to four different N application rates in India. We suggest that Indian budgets might be

significantly altered by replacing the constant Indian 0.58% EF with an N-rate–dependent EF. In particular, this change would likely lower emissions estimates from regions predominantly fertilized at low N inputs while increasing emissions estimates from highly fertilized areas. Please note that when linear regression equations (that are poorer fits than quadratic equations) are forced on our datasets (see Figs 5-6), the resulting EFs are 1.8% and 3.5% for groundnut and millets, respectively. These forced linear EFs are significantly higher than both the average global IPCC EF (1%) (51) and the national EF proposed by the Indian Government (0.58%) (29). Thus, both IPCC and Indian government’s EFs could be significantly underestimating the amount of the mitigation potential of alternate low nitrogen (LN) upland crop growing practices.

Implications

Differential impacts of low vs high N input upland crops

Our study clearly shows that low N treatments lead to lower N₂O emissions while increasing or maintaining yields and profits. We have established unequivocally that tropical soils in India also show a non-linear increase in N₂O with increasing N use when added N is beyond the total N requirement of the crop (13, 14, 19). Our data supports the interpretation that N₂O emissions are accelerated in soils fertilized in excess of crop requirements even when the number of fertilizer doses is more than one. Our data also implies that N₂O emissions are accelerated in tropical soils fertilized in excess of crop requirements even when soil carbon content is less than 1%. This implication is supported by a previous study from Mexico (16) while casting a doubt on conclusions from a recent study from Sri Lanka (20). In line with previous spatially explicit analysis (52), our study suggests that the largest mitigation gains (with respect to both N₂O emissions per unit area and N₂O emissions per unit yield) are to be made where fertilizer N is applied in great excess (e.g., in many irrigated areas of Indo-gangetic plain in India), and relatively small increase in N₂O emissions will occur due to modest increase in N addition in many rainfed cropping systems which currently involve low N application rates. In the interest of global food and economic security, we recommend continued research on both N₂O and yield scaled N₂O response curves from other tropical and developing parts of the world.

Market mechanisms for promotion of sustainable practices

Identifying farming practices that provide economic and environmental sustainability while also addressing climate change mitigation and resilience, are critical for ensuring that effective GHG mitigation options are widely implemented in the future (53). There are, however,

significant institutional and cultural barriers to the widespread adoption of alternative practices. While farmers might know about the drawbacks of excessive fertilizer use, they do not have ways to determine optimal N needed for best possible yields, resulting in low nutrient use efficiency and lower crop yields (54). Reliable and timely farmer advisory coupled with incentives are needed to shift farmers to a regime that supports nutrient optimization. In the absence of reliable farm advisory, and due to increasing market penetration of synthetic fertilizers, the opposite is true and there is a constant pressure on the farmers to use these fertilizers as a way to manage their perceived risk (see India-specific discussion in the supporting text). Thus, policies and market incentives need to be aligned to build farmer and institutional capacity to help promote alternative farming practices. This study suggests significant GHG mitigation potential exists for groundnut and millet cultivation systems in AEZ 8.2 (S13 Table) and AEZ 3.0 (Kritee et al, 2015) while also improving yields and farm incomes. Over the long term, these landscape level reductions in emissions could potentially be monetized, through international or domestic carbon markets (via N₂O emission reduction conversion to CO₂e.). It's worth considering if such market funds could be appropriate incentives and could be used to augment or catalyze, in some measure, the much larger public and private investments necessary to bring additional economic benefits from climate smart farming (CSF) or Low carbon farming (LCF) practices to farmers in these two regions. Our study supports that market instruments that specifically account for non-linear changes in N₂O might be more helpful in controlling N₂O emissions (55).

References

1. FAO. Climate-Smart Agriculture Sourcebook. Food and Agriculture Organisation (FAO) of the United Nations. Rome, Italy 2013.
2. Niles MT, Ahuja R, Barker T, Esquivel J, Gutterman S, Heller MC, et al. Climate change mitigation beyond agriculture: a review of food system opportunities and implications. *Renewable Agriculture and Food Systems*. 2018; 33(3):297-308. Epub 2018/02/13.
3. IPCC. Summary for Policymakers. In: *Climate Change and Land: an IPCC special report on climate change, desertification, land degradation, sustainable land management, food security, and greenhouse gas fluxes in terrestrial ecosystems* [P.R. Shukla, J. Skea, E. Calvo Buendia, V. Masson-Delmotte, H.-O. Pörtner, D. C. Roberts, P. Zhai, R. Slade, S. Connors, R. van Diemen, M. Ferrat, E. Haughey, S. Luz, S. Neogi, M. Pathak, J. Petzold, J. Portugal Pereira, P. Vyas, E. Huntley, K. Kissick, M. Belkacemi, J. Malley, (eds.)]. 2019.
4. Grace PR, Robertson GP, Millar N, Colunga-Garcia M, Basso B, Gage SH, et al. The contribution of maize cropping in the Midwest USA to global warming: A regional estimate. *Agricultural Systems*. 2011;104(3):292-6.
5. IPCC. Intergovernmental Panel on Climate Change, Working group I contribution to the Fifth Assessment Report, *Climate Change 2013: The Physical Science Basis*. Stockholm.: 2013.
6. Tian H, Xu R, Canadell JG, Thompson RL, Winiwarter W, Suntharalingam P, et al. A comprehensive quantification of global nitrous oxide sources and sinks. *Nature*. 2020;586(7828):248-56.
7. Stehfest E, Bouwman L. N₂O and NO emission from agricultural fields and soils under natural vegetation: summarizing available measurement data and modeling of global annual emissions. *Nutrient Cycling in Agroecosystems*. 2006;74(3):207-28.
8. Lesschen JP, Velthof GL, de Vries W, Kros J. Differentiation of nitrous oxide emission factors for agricultural soils. *Environmental Pollution*. 2011;159(11):3215-22.
9. Balaine N, Clough TJ, Beare MH, Thomas SM, Meenken ED, Ross JG. Changes in relative gas diffusivity explain soil nitrous oxide flux dynamics. *Soil Science Society of America Journal*. 2013;77(5):1496-505.
10. Albanito F, Lebender U, Cornulier T, Sapkota TB, Brentrup F, Stirling C, et al. Direct Nitrous Oxide Emissions From Tropical And Sub-Tropical Agricultural Systems - A Review And Modelling Of Emission Factors. *Scientific Reports*. 2017;7(1):44235.
11. Kim D-G, Hernandez-Ramirez G, Giltrap D. Linear and nonlinear dependency of direct nitrous oxide emissions on fertilizer nitrogen input: A meta-analysis. *Agriculture, Ecosystems & Environment*. 2013;168:53-65.
12. Philibert A, Loyce C, Makowski D. Quantifying Uncertainties in N₂O Emission Due to N Fertilizer Application in Cultivated Areas. *PLOS ONE*. 2012;7(11):e50950.
13. Shcherbak I, Millar N, Robertson GP. Global metaanalysis of the nonlinear response of soil nitrous oxide (N₂O) emissions to fertilizer nitrogen. *Proceedings of the National Academy of Sciences*. 2014;111(25):9199-204.
14. van Groenigen JW, Velthof GL, Oenema O, Van Groenigen KJ, Van Kessel C. Towards an agronomic assessment of N₂O emissions: a case study for arable crops. *European Journal of Soil Science*. 2010;61(6):903-13.
15. McLellan EL, Cassman KG, Eagle AJ, Woodbury PB, Sela S, Tonitto C, et al. The Nitrogen Balancing Act: Tracking the Environmental Performance of Food Production. *BioScience*. 2018;68(3):194-203.

16. Millar N, Urrea A, Kahmark K, Shcherbak I, Robertson GP, Ortiz-Monasterio I. Nitrous oxide (N₂O) flux responds exponentially to nitrogen fertilizer in irrigated wheat in the Yaqui Valley, Mexico. *Agriculture, ecosystems & environment*. 2018;261:125-32.
17. Eagle AJ, McLellan EL, Brawner EM, Chantigny MH, Davidson EA, Dickey JB, et al. Quantifying On-Farm Nitrous Oxide Emission Reductions in Food Supply Chains. *Earth's Future*. 2020;8(10):e2020EF001504.
18. Blackmer AM, Bremner JM. Inhibitory effect of nitrate on reduction of N₂O to N₂ by soil microorganisms. *Soil Biology and Biochemistry*. 1978;10(3):187-91.
19. Hoben JP, Gehl RJ, Millar N, Grace PR, Robertson GP. Nonlinear nitrous oxide (N₂O) response to nitrogen fertilizer in on-farm corn crops of the US Midwest. *Global Change Biology*. 2011;17(2):1140-52.
20. Liyanage A, Grace PR, Scheer C, de Rosa D, Ranwala S, Rowlings DW. Carbon limits non-linear response of nitrous oxide (N₂O) to increasing N inputs in a highly-weathered tropical soil in Sri Lanka. *Agriculture, ecosystems & environment*. 2020;292:106808.
21. Riley WJ, Ortiz-Monasterio I, Matson PA. Nitrogen leaching and soil nitrate, nitrite, and ammonium levels under irrigated wheat in Northern Mexico. *Nutrient Cycling in Agroecosystems*. 2001;61(3):223-36.
22. Thilakarathna M, Raizada M. A Review of Nutrient Management Studies Involving Finger Millet in the Semi-Arid Tropics of Asia and Africa. *Agronomy*. 2015;5(3):262.
23. Lata C, Gupta S, Prasad M. Foxtail millet: a model crop for genetic and genomic studies in bioenergy grasses. *Critical Reviews in Biotechnology*. 2013;33(3):328-43.
24. Veeramani P, Subrahmaniyan K. Nutrient Management for sustainable Groundnut Productivity in India- a review. *International Journal of Engineering Science and Technology*. 2011;3(11):8138-53.
25. Global Crop Production Downloadable Food and Agriculture Organization (FAO) Data [database on the Internet]. Food and Agriculture Organization. 2014 [cited March 28, 2016]. Available from: <http://faostat3.fao.org/download/Q/QC/E>.
26. GOI. Indian Fertilizer Scenario 2017 by Department of Fertilizers, Ministry of Chemicals and Fertilizers, India. Published by Government of India (GOI). Available at <http://fert.nic.in/page/fertilizers-scenario>. 2017.
27. GOI. Government of India, State of Indian Agriculture 2018-2019, Ministry of Agriculture Department of Agriculture & Cooperation. Available at <http://agricoop.nic.in/annual-report>. New Delhi: 2019.
28. Gajbhiye KS, Mandal C. Agro-Ecological Zones, their Soil Resource and Cropping Systems. Status of farm mechanization in India. Nagpur, India: National Bureau of Soil Survey and Land Use Planning. 2000.
29. Kritee K, Nair D, Tiwari R, Rudek J, Ahuja R, Adhya T, et al. Groundnut cultivation in semi-arid peninsular India for yield scaled nitrous oxide emission reduction. *Nutr Cycl Agroecosys*. 2015;103(1):115-29.
30. Reddy PR. Computing water requirement of groundnut. *Annals of Arid Zone*. 1988;27(3-4):247-51.
31. TNAU. Millet: Ragi Crop Production Guide in Tamil Nadu Agricultural University (TNAU) Agritech portal. http://agritech.tnau.ac.in/agriculture/millet_ragi.html. 2017.
32. Kritee K, Nair D, Zavala-Araiza D, Proville J, Rudek J, Adhya TK, et al. High nitrous oxide fluxes from rice indicate the need to manage water for both long- and short-term climate impacts. *Proc Natl Acad Sci* 101073/pnas1809276115. 2018.

33. Sankar GRM, Sharma KL, Dhanapal GN, Shankar MA, Mishra PK, Venkateswarlu B, et al. Influence of Soil and Fertilizer Nutrients on Sustainability of Rainfed Finger Millet Yield and Soil Fertility in Semi-arid Alfisols. *Communications in Soil Science and Plant Analysis*. 2011;42(12):1462-83.
34. MoA. Status paper on coarse cereals (Sorghum, Pearl Millet, Finger Millet, Small Millets, Maize and Barley) by Ministry of Agriculture (India), Department of Agriculture and Cooperation, Jaipur, Directorate of Millets Development. 2014.
35. Tiwari R, Kritee K, Adhya TK, Loecke T, Rudek J, Nair D, et al. Sampling guidelines and analytical optimization for direct greenhouse gas emissions from tropical rice and upland cropping systems. *Carbon Manag.* 2015;6(3-4):169-84.
36. Parkin TB, Kaspar TC. Nitrous oxide emissions from corn-soybean systems in the midwest. *J Environ Qual*. 2006;35(4):1496-506.
37. Flechard CR, Ambus P, Skiba U, Rees RM, Hensen a, van Amstel a, et al. Effects of climate and management intensity on nitrous oxide emissions in grassland systems across Europe. *Agriculture, Ecosystems & Environment*. 2007;121(1-2):135-52.
38. Parkin TB, Venterea RT, Hargreaves SK. Calculating the Detection Limits of Chamber-based Soil Greenhouse Gas Flux Measurements. *Journal of Environment Quality*. 2012;41:705-.
39. Parkin T, Venterea R. Chamber-Based Trace Gas Flux Measurements. In: USDA ARS GRACEnet Project Protocols. Editor: R.F. Follett. <http://www.ars.usda.gov/SP2UserFiles/Program/212/Chapter%203.%20GRACEnet%20Trace%20Gas%20Sampling%20Protocols.pdf>. 2010.
40. Myhre G, D. Shindell, F.-M. Bréon, W. Collins, J. Fuglestedt, J. Huang, et al. Anthropogenic and Natural Radiative Forcing. In: Stocker TF, D. Qin, G.-K. Plattner, M. Tignor, S.K. Allen, J. Boschung, et al., editors. *Climate Change 2013: The Physical Science Basis Contribution of Working Group I to the Fifth Assessment Report of the Intergovernmental Panel on Climate Change*. Cambridge, United Kingdom and New York, NY, USA.: Cambridge University Press; 2013.
41. Dick J, Kaya B, Soutoura M, Skiba U, Smith R, Niang a, et al. The contribution of agricultural practices to nitrous oxide emissions in semi-arid Mali. *Soil Use and Management*. 2008;24(3):292-301.
42. Ramu K, Watanabe T, Uchino H, Sahrawat KL, Wani SP, Ito O. Fertilizer induced nitrous oxide emissions from Vertisols and Alfisols during sweet sorghum cultivation in the Indian semi-arid tropics. *Science of The Total Environment*. 2012;438:9-14.
43. Jain N, Arora P, Tomer R, Mishra SV, Bhatia A, Pathak H, et al. Greenhouse gases emission from soils under major crops in Northwest India. *Science of The Total Environment*. 2016;542:551-61.
44. Khalil MI, Van Cleemput O, Rosenani aB, Schmidhalter U. Daytime, Temporal, and Seasonal Variations of N₂O Emissions in an Upland Cropping System of the Humid Tropics. *Communications in Soil Science and Plant Analysis*. 2007;38(1):189-204.
45. Xiong Z, Xing G, Tsuruta H. Field study on nitrous oxide emissions from upland cropping systems in China. *Soil science and plant nutrition*. 2002;48(4):539-46.
46. Fagodiya RK, Pathak H, Bhatia A, Jain N, Gupta DK, Kumar A, et al. Nitrous oxide emission and mitigation from maize–wheat rotation in the upper Indo-Gangetic Plains. *Carbon Management*. 2019;10(5):489-99.

47. Parihar CM, Parihar MD, Sapkota TB, Nanwal RK, Singh AK, Jat SL, et al. Long-term impact of conservation agriculture and diversified maize rotations on carbon pools and stocks, mineral nitrogen fractions and nitrous oxide fluxes in inceptisol of India. *Science of The Total Environment*. 2018;640-641:1382-92.
48. Sapkota TB, Singh LK, Yadav AK, Khatri-Chhetri A, Jat HS, Sharma PC, et al. Identifying optimum rates of fertilizer nitrogen application to maximize economic return and minimize nitrous oxide emission from rice–wheat systems in the Indo-Gangetic Plains of India. *Archives of Agronomy and Soil Science*. 2020:1-16.
49. MoEF. Government of India's Second National Communication to the United Nations Framework Convention on Climate Change. New Delhi: Ministry of Environment, Forest and Climate Change; 2012.
50. Bhatia A, Jain N, Pathak H. Methane and nitrous oxide emissions from Indian rice paddies, agricultural soils and crop residue burning. *Greenhouse Gases: Sci Technol*. 2013;16:1-16.
51. de Klein C, Novoa RSA, Ogle S, Smith KA, Rochette P, Wirth TC, et al. N₂O emissions from managed Soils, and CO₂ emissions from Lime and urea application in 2006 IPCC Guidelines for National Greenhouse Gas Inventories. (Institute for Global Environmental Strategies, Hayama, Japan). 2006. p. 1-54.
52. Gerber JS, Carlson KM, Makowski D, Mueller ND, Garcia de Cortazar-Atauri I, Havlik P, et al. Spatially explicit estimates of N₂O emissions from croplands suggest climate mitigation opportunities from improved fertilizer management. *Glob Change Biol*. 2016;22(10):3383-94.
53. Smith P, Martino D, Cai Z, Gwary D, Janzen H, Kumar P, et al. Policy and technological constraints to implementation of greenhouse gas mitigation options in agriculture. *Agriculture, Ecosystems & Environment*. 2007;118(1-4):6-28.
54. EPI. Earth Policy Institute, Data Highlights: Many Countries Reaching Diminishing Returns in Fertilizer Use. 2014.
55. Rosas F, Babcock BA, Hayes DJ. Nitrous oxide emission reductions from cutting excessive nitrogen fertilizer applications. *Climatic Change*. 2015;132(2):353-67.

Supporting information

Supporting text

Introduction

Finger-millet: Globally, finger-millet is grown in >3.6 million ha (FAOSTAT, 2014; ICRISAT, 2015). Because of its resistance to pests, high calcium, iron, polyphenols and dietary fibre content (Devi et al., 2014), finger-millet is one of the most important millet in the tropics (ICRISAT, 2015). With >40% of the global area under finger-millet (GOI, 2021), India produces ~2 million tons every year (GOK, 2015c; Thilakarathna and Raizada, 2015).

Foxtail-millet: Foxtail-millet, another highly nutritious and hardy millet, is one of the oldest cultivated grain crops and is a dietary staple in the arid and semiarid regions of Asia, North Africa, South and North America. With ~1 million ha, one fourth of total global area under foxtail-millet, India is the fourth largest producer in the world of this short-duration millet (Upadhyaya et al., 2009). Foxtail-millet ranks second in total world production of millets with ~6 million metric tons a year (Lata et al., 2013) and has recently been studied extensively as a key target for genetic transformation due to its genetic and physiological likeness to biofuel crops (Lata et al., 2013).

Groundnut: Groundnut, a nitrogen-fixer, is globally the fourth most important oilseed crop with 44 Mt grown over 26 Mha (FAOSTAT, 2014). With 5-10 Mt year⁻¹, groundnut accounts for 25-55% of total oilseeds production in India (FAOSTAT, 2014; GOI, 2021; Veeramani and Subrahmaniyan, 2011).

In India, marginal and small-holder (<2 ha) farms are extremely important because they account for 75-85% of all the farmers and a 35-55% of all the cropland area in the area (GOI, 2017; GOK, 2015a).

Importance of regional studies to determine emission factors

The Intergovernmental Panel on Climate Change (IPCC) provides a default emission factor (EF) of 1% of N applied to agricultural fields in any chemical form as an estimate of N₂O being released to the atmosphere (de Klein et al., 2006). This default was developed based on

data from many countries and does not take into account variability in soil and crop types, climate conditions, and management regimes (Lesschen, 2011) and IPCC recommends developing regional EFs. For these regional EFs to be statistically robust, emission measurements must be conducted over multiple seasons for a particular crop in a given agro-ecological region (de Klein et al., 2006). Despite the relative ease of applying linear emissions models to estimate N₂O emissions from crops, recent observations suggest that N₂O emissions accelerate with increased N application.

Although N₂O emissions from rice-wheat systems in northern India have been extensively measured, a very limited number of studies report emissions from non-wheat upland crops grown in north India (Majumdar, 2000) and there are no published studies on upland crops from peninsular India except our recent study on groundnut (Kritee et al., 2015). This absence of country-wide (and agro-ecological region and crop-management specific) agricultural emission data and a concomitant lack of understanding of mitigation and drought-resilience potential of alternate farming practices indicates the importance of developing crop and region specific EFs.

Methods

Location of farms

Our finger-millet farms were located in agro-ecological region (AER) 8.2 in Karnataka, the leading finger-millet growing state that produces ~65% of finger-millet in India (GOK, 2015c; ICRISAT, 2015). About 50% of the total area under groundnut in Andhra Pradesh (or about 1/6th of the groundnut hectares in India) is within the Anantapur district in AER 3.0, the site of our groundnut and foxtail-millet farms. Over 65% and 75% of the total cultivated area is under finger-millet and groundnut in Ramanagara (GOI, 2011; GOK, 2015b) and Anantapur (Kritee et al., 2015) districts, respectively. Andhra Pradesh is also the leading foxtail-millet producing state in India (MoA, 2014). Both governmental (MoA, 2014) and non-governmental agencies are actively reintroducing foxtail-millet in the study region AER 3.0 due to its drought tolerance and highly nutritional qualities.

Agro-ecological region 8.2 (Gajbhiye and Mandal, 2000; GOI, 2011) is characterized by deep red clayey soils, hot-moist semi-arid climate and is dominated by a growing season length of 120-150 days, and soils that are well drained and of low to medium water-holding capacity. Average annual rainfall is about ~820 mm (GOI, 2011) of which 25-55% falls from July–December (Table 2). Over 99.5% of all finger millet grown in Ramanagara is grown during *kharif* (rainfed) season (GOI, 2011).

The study farms for foxtail-millet and groundnut were located in Anantapur district and are classified under agro-ecological region 3.0. Our previous study (Kritee et al., 2015) on groundnut presents other characteristics of the region in detail. Please see SI Table 1 for details related to location, elevation, soil qualities weather and seed varieties.

Low N treatments

The potential climate-smart farming practices investigated for foxtail-millet and groundnut farms in AER 3.0 involved completely organic (with no synthetic) inputs that were decided by agronomists from local non-governmental (NGO) partners who have been actively engaged in local experiments with a variety of organic fertilizers. Preparation and nutritional qualities of different fermented organic manures (i.e., ghanajeevamrutha and jeevamrutha have been explained earlier (Kritee et al., 2015; Kumar et al., 2011). For finger-millet, the alternative practices were based on TNAU Crop Production guide for rainfed finger-millet (TNAU, 2017) but the use of organic matter (FYM) was limited in spite of much higher recommendations. This was because our surveys showed that the farmers had access to limited livestock and could not afford the high cost of FYM in AER 8.2. Involvement of local farmers ensured that only those practices were propagated which were easy to implement given the logistical, socio-economic and cultural constraints in the region (e.g., discontinuation of use of Single Super Phosphate for finger-millet in 2015 because it became locally non-available) (Table 1).

High N treatment for finger-millet (ragi)

The total N application rates in the High-N treatments (213-248 kg N ha⁻¹) were based on inadvertent errors in the processing of these farmer surveys. Crucially, these rates are significantly higher than the total N application rates (133-185 kg N ha⁻¹) based on the average finger-millet-specific district level survey data published by the Indian Department of Agriculture & Cooperation for the years 2001-2012 (see below). Hence, we recommend use of 150 kg N ha⁻¹ as the conventional N application rate for finger-millet when calculating climate mitigation benefits of Low-N alternate treatment over conventional treatment.

The rate of 150 kg N ha⁻¹ for finger-millet in the study district (Ramanagara, previously a part of Bangalore Rural district) was determined based on district level survey data published by the Indian Department of Agriculture & Cooperation. The information can be accessed through the online “Input Survey Database”, which is a part of the Agricultural Census. The database

provides district level information specific for a particular crop and fertilizer type, with a breakup for different land classes, for the years 1996-97, 2001-02, 2006-07 and 2011-12.

Based on our preliminary farmer surveys, we had determined that farmers in the study area most commonly apply farmyard manure (FYM), Di-ammonium phosphate (DAP) and Urea for finger-millet cultivation. Therefore, for the determination of conventional N application rate for finger-millet, we collected information for the application rates of FYM, DAP and Urea for Ragi cultivation on marginal landholding for the years 2001-02, 2006-07 and 2011-12 using the online Input Survey Database (GOI, 2017).

The database provided information for FYM and Urea application rates for finger-millet cultivation for all the three selected years. However, information on DAP application rates were not available for 2006-07 and 2011-12 and were assumed to remain constant. Analysis of data for application rates on marginal landholding is presented in the table below.

Year	FYM (kg/ha)	DAP (kg/ha)	Urea (kg/ha)	Total N (kg/ha)
2001-02	6911	75	267	185
2006-07	7452	75	144	133
2011-12	7227	75	170	143
Average	7197	75	194	153

High N treatments for groundnut and foxtail-millet

When we began groundnut study, district level fertilizer use/sale data was available via Government of India (e.g., Department of Fertilizers: <http://fert.nic.in/sales-availability-district-wise-report>). However, this fertilizer use/sale data was aggregated without indication of distribution of total N use among different crops and farm-sizes. Indian government also provided district level crop production data (Government of India, Crop production statistics information system: <http://apy.dacnet.nic.in/>) but the total district level fertilizer use could not be divided among different crops because differences in socio-economic backgrounds among marginal-small-holder farmers and medium/large-holder farmers, soil types and seed varieties drives different fertilizer/manure use at different farms. Fertilizer/manure use recommended by various local academic and government institutes varied and, hence, we had no other means to establishing baseline farming practices except by conducting farmer questionnaire surveys. In SI Table 3, we present summary of results from our surveys for dry *kharif* season in Anantapur district in 2013-2014. These surveys were conducted before the start of the two dry *kharif* seasons. The entire dataset collected by the participating NGO can be made available upon request.

Inter-cropping

While there are no cover or inter-crops used during groundnut cultivation in the region (Kritee et al., 2015), use of row/border inter-crops along with millets is a common practice. All finger-millet (*ragi*) plots had the following row/border crops: cowpea (*Vigna unguiculata*), lab-lab (*Dolichos lablab*), pigeon pea (*Cajanas cajan*), niger (*Guizotia abyssinica*), sorghum (*Sorghum vulgare*), mustard (*Brassica nigra*) and castor (*Ricinus communis*) in variable amounts. Very high and high N foxtail-millet (*Korra*) plots had redgram as intercrop and low N plots had other intercrops as well (*Korra* : Red Gram : *Bajra* : *Jowar* with ratios 20: 1:1:0.5). All yields reported in Table 1 have been area-corrected for inter-crops. The soils in the area are not amenable to cultivation without ploughing and, therefore, tillage procedures all treatments were similar. Cover crops are not utilized in this region and were not a part of the study.

Tillage/ploughing

While farmers engaged in sustainable farming do not use tractors as often as mainstream farmers, tillage procedures for all treatments for a given crop were similar in our study.

In general, the soils in the two agro-ecological regions are not amenable to cultivation without ploughing. For finger-millet (*ragi*), before sowing, farmer ploughs the farm 2-4 times after rain events between March to July. The last ploughing event occurs 20-30 days before sowing and involves manure incorporation. When the soil is hard during summer and/or weeding is necessary, farmers hire tractors for the first 2-3 tillage events. Subsequent events involve country plough. Tractor ploughing involve ploughing at a depth of 12-18 inch whereas country plough penetrates the soil about 12 inch deep. The latter tilling events will involve levelling using involving mild ploughing/levelling tools such as *kunte*, *heggunte* and *halbe*.

For groundnut, tillage (two rounds) was done once for each season (24-28 days before sowing). In *kharif*, it was done using a metallic plough attached to a bullock cart (locally called *Madaka*) but in *rabi*, it was done using a local tractor. Local term for ploughing is '*Dhunedhi*'. Bullock cart based ploughing tills soil to the depth of 12 cm and tractor based ploughing upto the depth 18 cm.

Mineralization rates

Mineralization rates for organic nitrogen were estimated based on approach described in our previous study (Kritee et al., 2018). Briefly, all of the N content in any organic input is not

labile. In addition, the labile N in organic inputs added at a given point of time mineralizes slowly over a period of ~3 years (Shimizu et al., 2009). Thus, for every season, cumulative available N (or mineralized N) contributed by organic matter was influenced by OM added over three years (the season of interest plus the two preceding years). The % organic N mineralized during a fixed time interval depends on seasonal temperature, soil properties, microbial activity, etc (Mohanty et al., 2011; Pratt and Castellanos, 1981). In the absence of any regional measurements of mineralization rates of organic N, we used three different sets of mineralization percentages (% total organic N mineralized in the first (that is, year of) and second, and third years (after) the addition of organic matter) to calculate the maximum and minimum N content utilized in our regression analysis (Table 1, Main text). One set of N mineralization rates (13%, 7.0% and 5.5%, respectively, in the first, second, and third year after application) was based on the Uchida model developed for Japan (Shimizu et al., 2009; Shimizu et al., 2010). Another set of mineralization percentages (45%, 20% and 10%) were based on studies made by several agricultural extension centers in the United States (PennState, 2016; Pratt and Castellanos, 1981). The third set of mineralization percentages (10%, 40% and 15%) were based on local expert advice which suggested that if farmers add organic inputs every third year in peninsular India, they get maximum yields in the second year after application of organic inputs. Additionally, it was suggested that, in peninsular India, yields are significantly lower during the year of organic application and during the third year after the organic application. We are not in a position to evaluate which of these mineralization rates is best applicable to our farms and hence present the minimum and maximum possible mineralized N available due to addition of organic inputs at all farms in Table 1.

Multiple regression models

We note that our objective with the multiple regression modeling was to confirm if N₂O emissions increase non-linearly with N fertilization rate. We did explore the correlations among the N₂O emissions and additional parameters (rainfall, SOM, seed rate etc) using this same multiple regression modeling approach. We show the performance of these alternative models below. Here, we make the distinction between confirmatory hypothesis testing (N₂O as a function of N rate) and exploratory analysis (e.g., seeding rate and N₂O emissions). Given our study was not designed to disentangle each component of the alternative management practices, we don't find it responsible to present other models with the same confidence as we do with the N rate models.

Equations for finger- and foxtail- millet:

Equation	Multiple R ²	Adjusted R ²	p value	AIC
Quadratic, rainfall as categorical variable:				
Low rainfall equation:				
$N_2O-N \text{ (kg ha}^{-1}\text{)} = [6.34e^{-05} (N_{total})^2 + 3.26e^{-03} (N_{total}) - 0.59]$	0.97	0.96	8.9e ⁻⁰⁸	54
High rainfall equation				
$N_2O-N \text{ (kg ha}^{-1}\text{)} = [6.34e^{-05} (N_{total})^2 + 3.26e^{-03} (N_{total}) + 1.48]$				
*all parameters statistically significant (p < 0.05)				
Quadratic, with SOM as continuous variable:				
$N_2O-N \text{ (kg ha}^{-1}\text{)} = [6.34e^{-05} (N_{total})^2 + 1.36e^{-03} (N_{total}) + 2.39(SOM) - 1.93]$	0.96	0.95	1.4e ⁻⁰⁷	56
SOM is not statistically significant				
Quadratic, with rainfall as continuous variable:				
$N_2O-N \text{ (kg ha}^{-1}\text{)} = 5.97e^{-05} (N_{total})^2 + 4.86e^{-03} (N_{total}) + 4.24e^{-03} (Rainfall) - 1.19$	0.96	0.95	3.5e ⁻⁰⁸	58
Rainfall is not statistically significant				
Quadratic, without rainfall:				
$N_2O-N \text{ (kg ha}^{-1}\text{)} = [6.35e^{-05} (N_{total})^2 + 3.76e^{-03} (N_{total}) - 8.8e^{-02}]$	0.95	0.94	8.5e ⁻⁰⁸	59
Linear, with rainfall as categorical:				
Low rainfall equation				
$N_2O-N \text{ (kg ha}^{-1}\text{)} = 0.035 (N_{total}) - 2.10$	0.93	0.91	6.4e ⁻⁰⁷	64
High rainfall equation				
$N_2O-N \text{ (kg ha}^{-1}\text{)} = 0.035 (N_{total}) - 0.019$				
Linear:				
$N_2O-N \text{ (kg ha}^{-1}\text{)} = 0.035(N_{total}) - 1.60$	0.91	0.90	1.7e ⁻⁰⁷	66

Importance of variables other than inorganic and organic nitrogen inputs:

Rainfall and SOM (Soil organic matter) content are not individually significant as continuous variables in our model. We note that there is a significant linear relationship/correlation ($r = 0.88$) between rainfall (mm) and SOM for the complete millet dataset and this explains why the equations containing SOM and rainfall as continuous variables have similar AIC values. The Rainfall and SOM terms explain a similar fraction of variance (for each respective equation). The rainfall amount as a categorical variable would also be highly correlated with SOM. It is possible that rainfall as a categorical variable captures parameters other than SOM.

Analyzing the combined datasets of the two millets: When we replicated this same analysis with only finger millet, the results were very similar such that a quadratic equation, with rainfall as categorical variable has the best predictive power (highest R^2) and lowest AIC. When we only considered finger-millet, we tested if SOM was a statistically significant predictor. However, both for the quadratic as well as the linear equation, SOM as a continuous variable was not statistically significant and was not adding any significant explanation of the variance. We note that Shcherbak et al (2014) made a powerful case for all the non-leguminous non-rice crops to be combined and we have followed their lead in combining the two non N-fixing crops. When we tested millet type (foxtail vs. finger millet) as a categorical variable, it was not statistically significant and further supports treating the two millets as a part of a group.

Equations for Groundnut

Equation	Multiple R^2	Adjusted R^2	p value	AIC
Quadratic, including seed rate: $N_2O-N \text{ (kg ha}^{-1}\text{)} = 2.34e^{-04}(N_{\text{total}})^2 - 1.82e^{-03}N_{\text{total}} + 1.06e^{-02}(\text{seed rate}) - 9.14e^{-01}$ All parameters are statistically significant	0.97	0.94	0.007	-3.3
Quadratic: $N_2O-N \text{ (kg ha}^{-1}\text{)} = 2.18e^{-04}(N_{\text{total}})^2 - 1.61e^{-03}N_{\text{total}} + 0.668$	0.86	0.79	0.019	6.4
Linear: $N_2O-N \text{ (kg ha}^{-1}\text{)} = 0.0178(N_{\text{total}}) + 0.419$	0.77	0.72	0.009	8.0

We note that quadratic equation including linear dependence on groundnut seed rate at the time of sowing can apparently explain a lot more variance in the data than the equation without seed rate. However, we cannot explain the biogeochemical reasoning behind this statistical result. Yield can be an indicator of N fixation by the crop our regression analysis showed that pod yield was not significant as a continuous variable. Given our study was not designed to disentangle each component of the alternative management practices, we don't find it responsible to present other models with the same confidence as we do with the N rate models. Quadratic yield equation is not statistically significant.

Discussion and implications

Inefficient fertilizer use in India

India is currently the second largest consumer of fertilizers in the world after China (Sharma and Thaker, 2011), with fertilizer use intensity (both per unit hectare and per unit yield) increasing steadily since 1960. While domestic fertilizer production has not increased significantly since the late 1990s (GOI, 2019), NPK fertilizer demand in India is projected to increase to >40 Mt by 2020, a 50% increase over 2010 (Sharma and Thaker, 2011). Between 2005 and 2010, annual fertilizer use per unit land area increased 7% in India, but crop yields increased by only ~2% (Sharma and Thaker, 2011). Another indication of the low nutrient use efficiency in India is that grain production per unit fertilizer is half of that of the U.S. (EPI, 2014). In the absence of a concerted efforts to improve crop advisories for increasing yields per unit nitrogen use, the increased use of fertilizers will cause a non-linear increase in nation's N₂O emissions without addressing yield gaps (van Groenigen et al., 2010).

Importance of high intensity sampling

We could find no published data on the annual N₂O emissions from finger- or foxtail-millet cultivation in India or the world. Even globally, we found limited number of published field studies documenting N₂O emissions from other millets. The sampling regime utilized in previous studies on millets might not have captured all possible N₂O emission peaks because of the limited number of days on which field sampling was undertaken (Parkin, 2008). For example, measurements on Pearl-millet in Mali included only seven measurements during the season in which it rained on 36 distinct days (Dick, 2008). In accordance with studies which report GHG

emission data following intense sampling (e.g., Parkin & Kaspar 2006 and references therein), our results show that for non-rice crops, it can take between 2-4 days for N₂O emissions to rise and come back to “background levels” after a significant rainfall event (>10 mm) and suggest that more continuous sampling should be done following each rain event.

Importance of involvement of local stakeholders and farmers

This study, which was a part of a multi-year agricultural GHG emission reduction project and a long term program to promote climate smart farming practices among small-scale farmers in peninsular India, explored the potential of N management to reduce N₂O emissions by increasing N use efficiency (or decrease N surplus), while improving crop productivity and farm income. Since we conducted our study at farmers’ fields, the conditions of the farm were not artificially controlled, and temperature, rainfall/irrigation patterns represent the agro-ecological conditions faced by >640,000 ha in the entire AER 8.2 for finger-millet (see Figure 1 and SI Table 13) and ~980000 ha for groundnut in AER 3.0 (Kritee et al, 2015). The co-production of knowledge with stakeholders with multi-directional flows of information helps increase the confidence of the farming community in the efficacy of new techniques and should lead to increased implementation of best management practices (BMPs) as determined by this project (Snyder et al., 2009), and will help to reduce concerns associated with reducing nitrogen use.

Supporting figures

S1 Fig. Impact of rainfall on yields during three foxtail-millet cropping seasons:

Foxtail millet requires 200-400 mm of rainfall (MOA, 2014). In 2013, lesser inorganic N was used for the High-N treatment than in 2014 (40 instead of 49 kg N ha⁻¹ with similar organic inputs for both LN and HN). However, the year 2013 recorded ~300 mm seasonal rainfall while the year 2014 recorded much lower seasonal rainfall (~56.9mm) after resowing. Thus yields in 2013 were much higher 1059 ± 5(HN) and 959± 5 (LN) kg ha⁻¹ than the year 2014 which recorded very low yields <200 kg ha⁻¹. Average yield in 2015 for various Low N practices at >30 farms was ~460 kg.ha⁻¹ when the rainfall of 127 ± 25 mm was observed at five weather stations across the region. As can be seen in the figure below, sowing in 2014 was done in the month of September followed by ~4 rain events which was not sufficient for seed germination resulting in a need to resow foxtail millet seeds in mid-October. Please note that GHG emissions could not be monitored in 2013 and 2015.

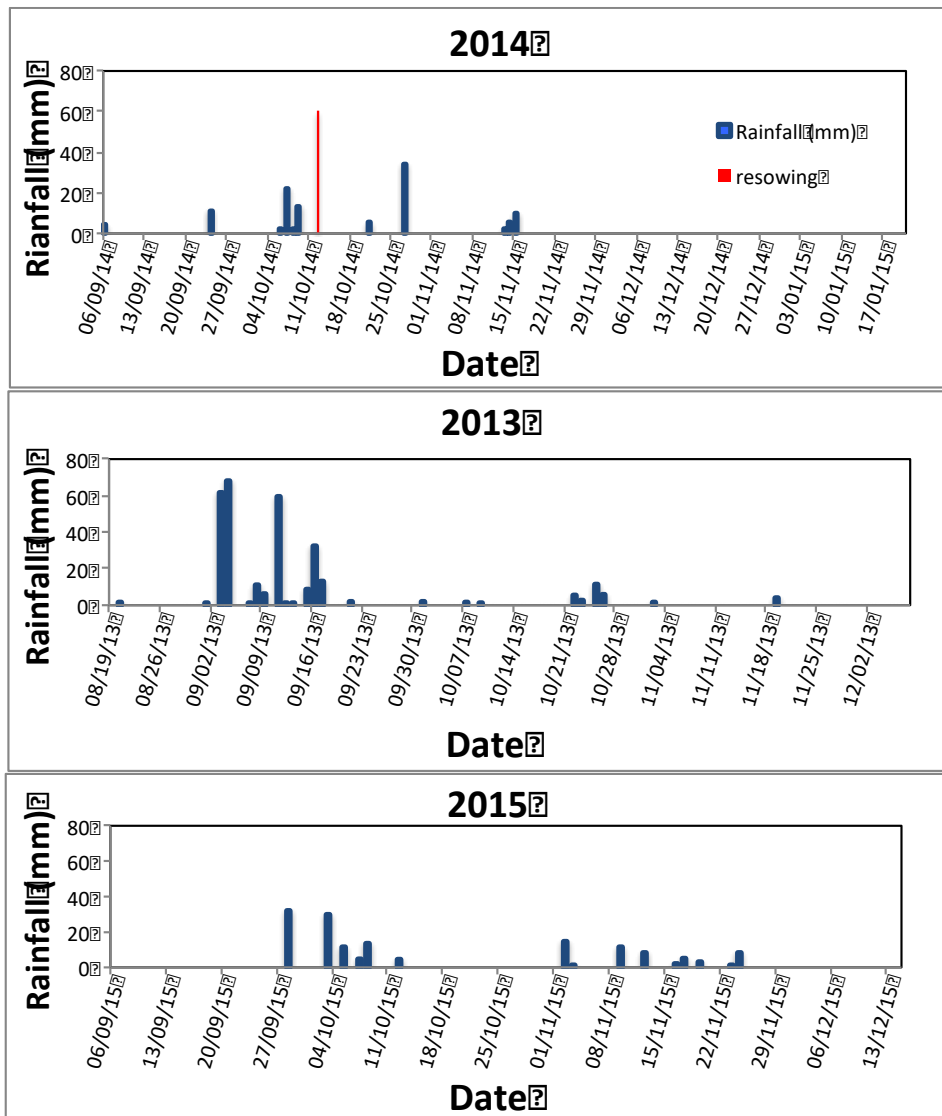

S2 Fig. High N₂O flux in fallow period after foxtail-millet growing season

This figure shows N₂O fluxes recorded at three replicate high N (mainstream) agriculture sub-plots with same nitrogen fertilizer use at a foxtail-millet farm in 2014. Red lines represent timing of the addition of N fertilizers. Blue lines represent rainfall recorded in the weather station next to the farm. N₂O emission peak during fallow period (30 days after harvest or 135 after sowing) likely because of rainfall and inorganic nitrogen left in the soil.

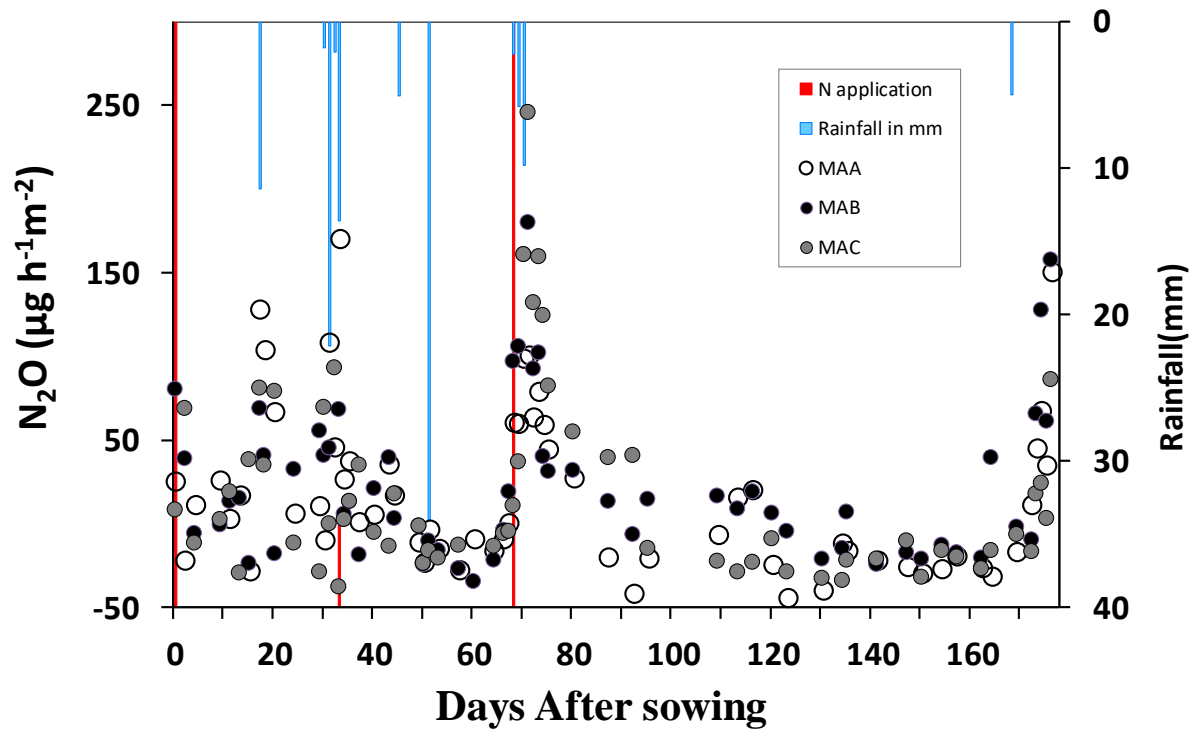

S3 Fig. Average N₂O flux (with ± SE) for finger-millet for high rainfall site in 2015

This figure shows average N₂O fluxes recorded at replicate treatments. Here, X-axis represents days after sowing. Red lines represent timing of the addition of N fertilizers. Blue lines represent rainfall recorded in the weather station next to the farm. FYM addition, if any, before sowing has not been shown. Please notice that the scale of Y axis differs significantly across different treatments.

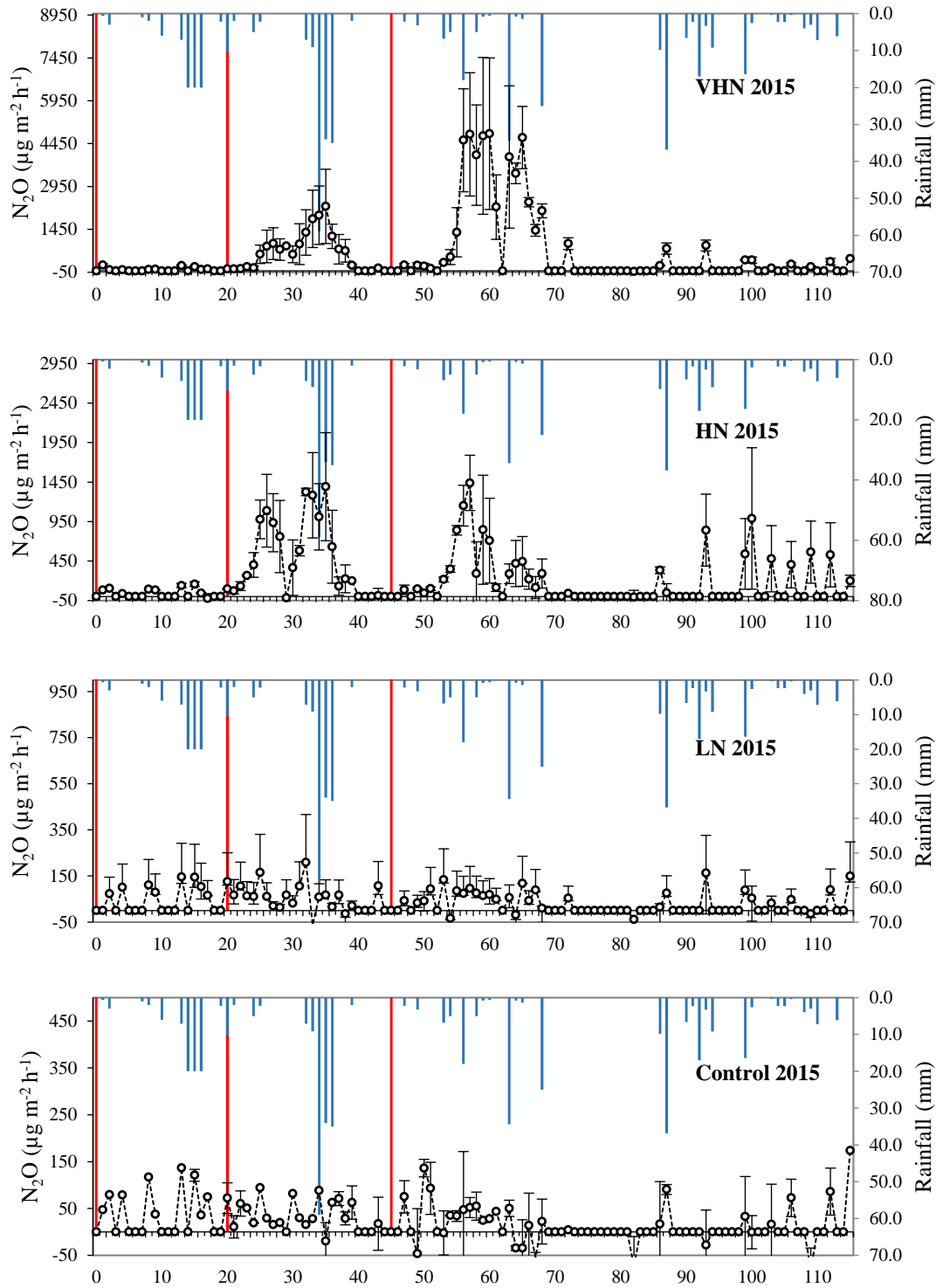

S4 Fig. Average N₂O flux (with ± SE) for finger-millet for low rainfall site (2012-2014)

This figure shows average N₂O fluxes recorded at replicate treatments. Here, X-axis represents days after sowing. Red lines represent timing of the addition of N fertilizers. Blue lines represent rainfall recorded in the weather station next to the farm. FYM addition, if any, before sowing has not been shown. Please notice that the scale of Y axis differs significantly across different treatments.

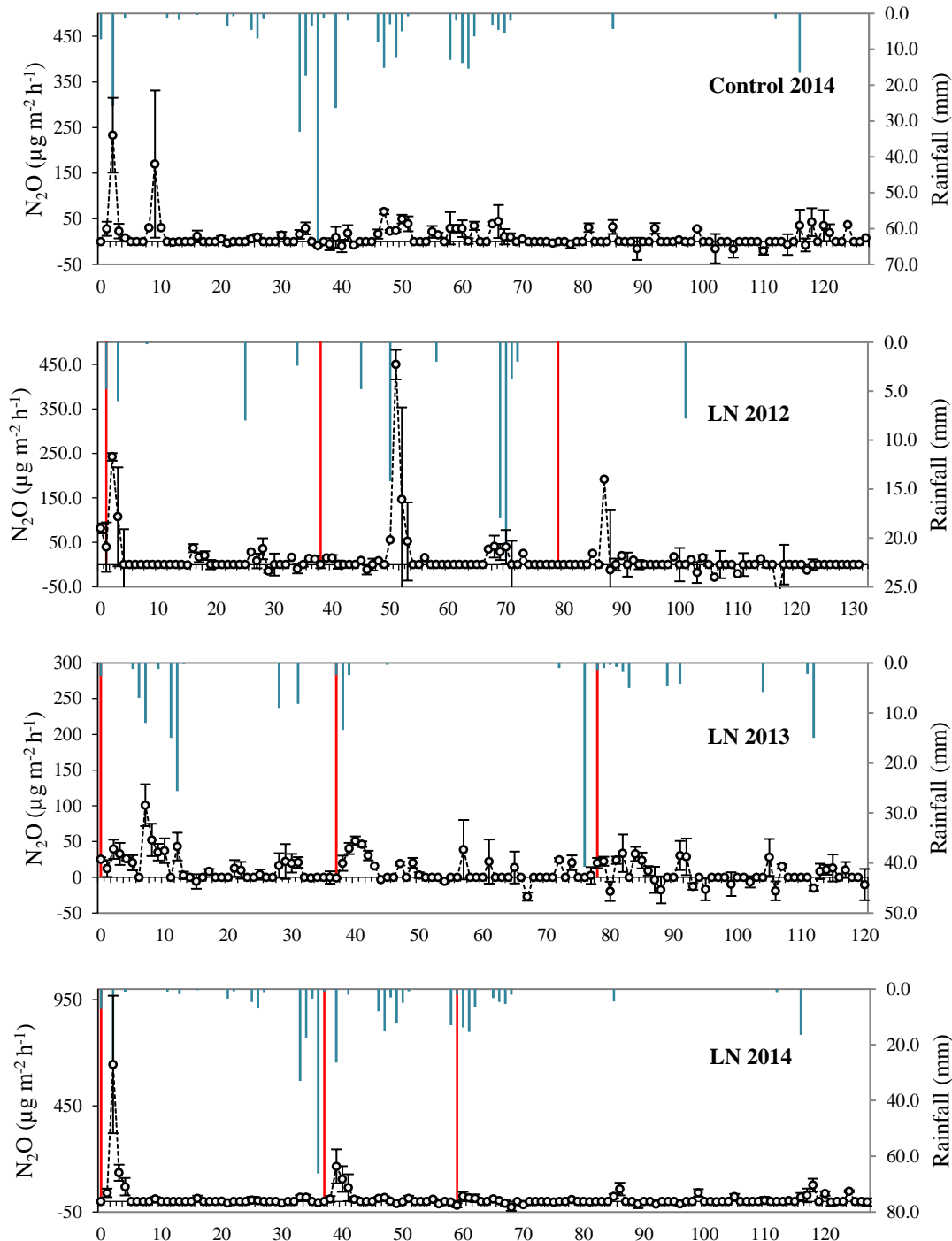

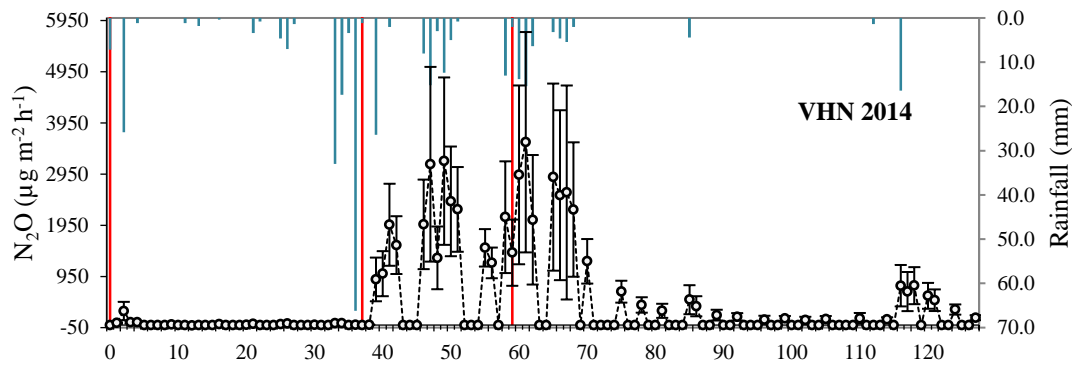
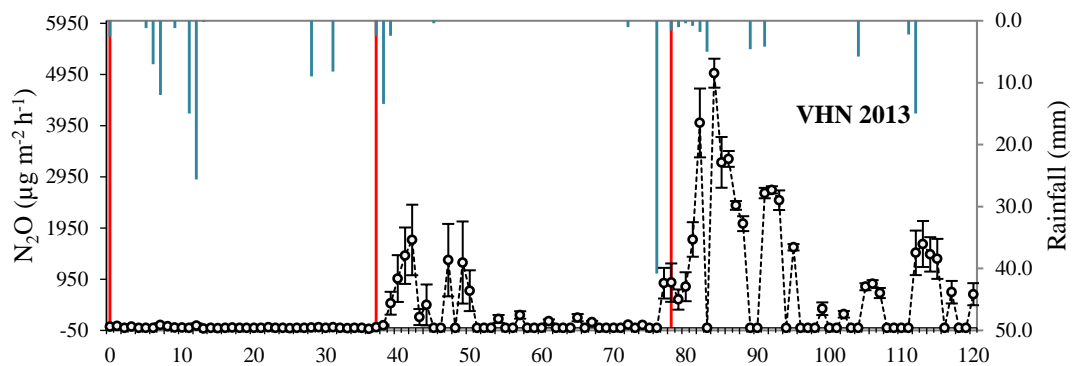
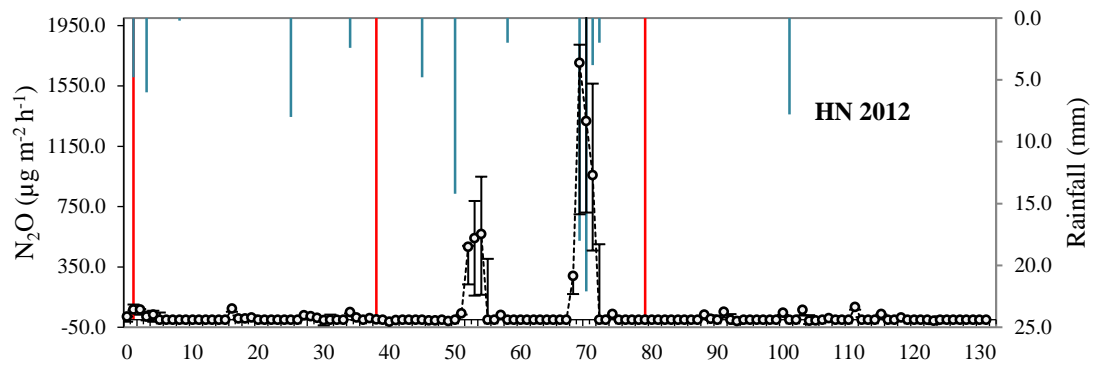

S5 Fig. Average N₂O flux (with ± SE) for foxtail-millet in 2014

This figure shows average N₂O fluxes recorded at replicate treatments. Here, X-axis represents days after sowing. Red lines represent timing of the addition of N fertilizers. Blue lines represent rainfall recorded in the weather station next to the farm. FYM addition, if any, before sowing has not been shown. Please notice that the scale of Y axis differs significantly across different treatments.

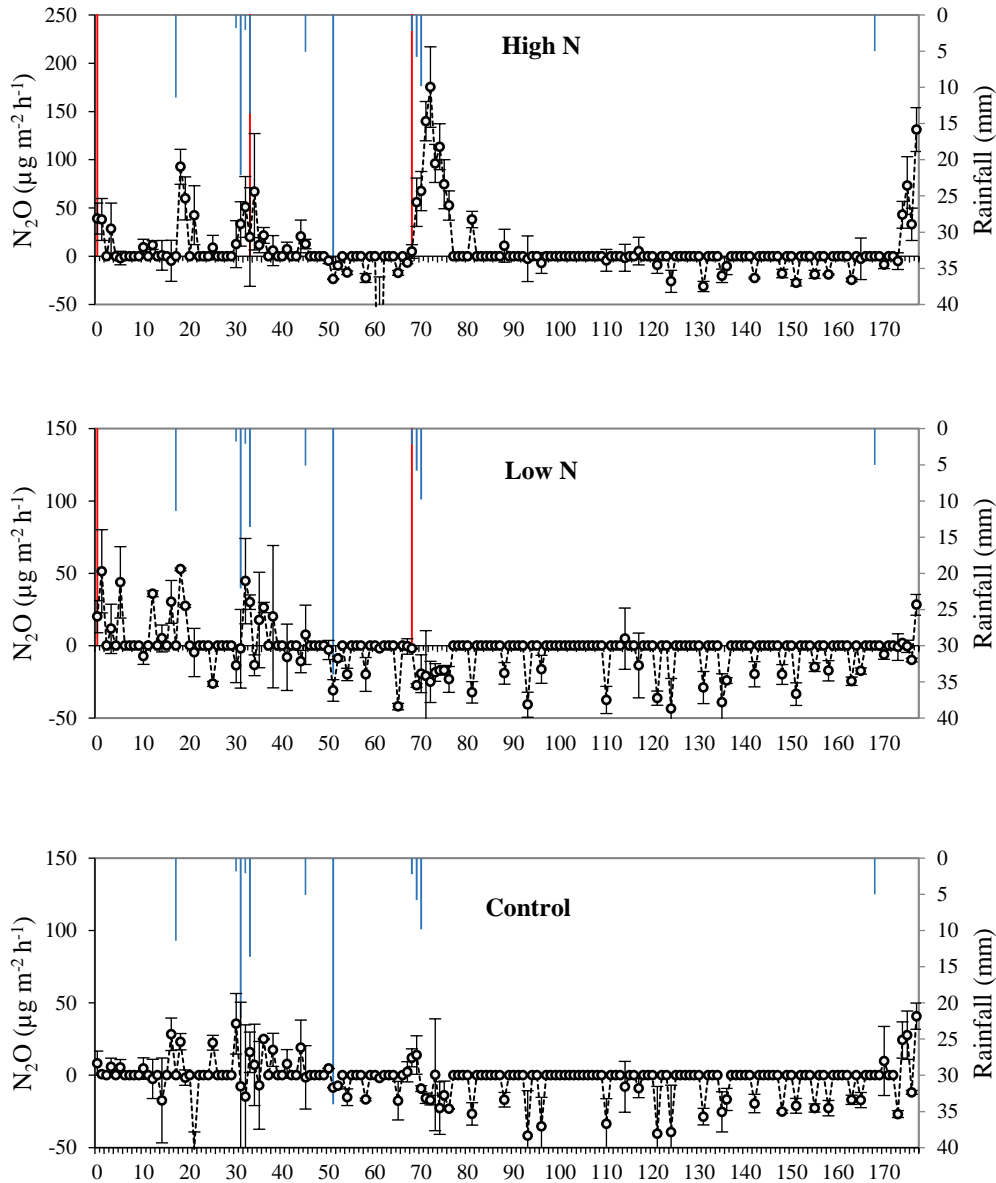

S6 Fig. Average N₂O flux (with ± SE) for groundnut in *kharif* (2012-2014)

This figure shows average N₂O fluxes recorded at replicate treatments. Here, X-axis represents days after sowing. Red lines represent timing of the addition of N fertilizers. Blue lines represent rainfall recorded in the weather station next to the farm. FYM addition before sowing has not been shown. Please note that the data from 2012 has already been published in Kritee et al (2015). Please notice that the scale of Y axis differs significantly across different treatments.

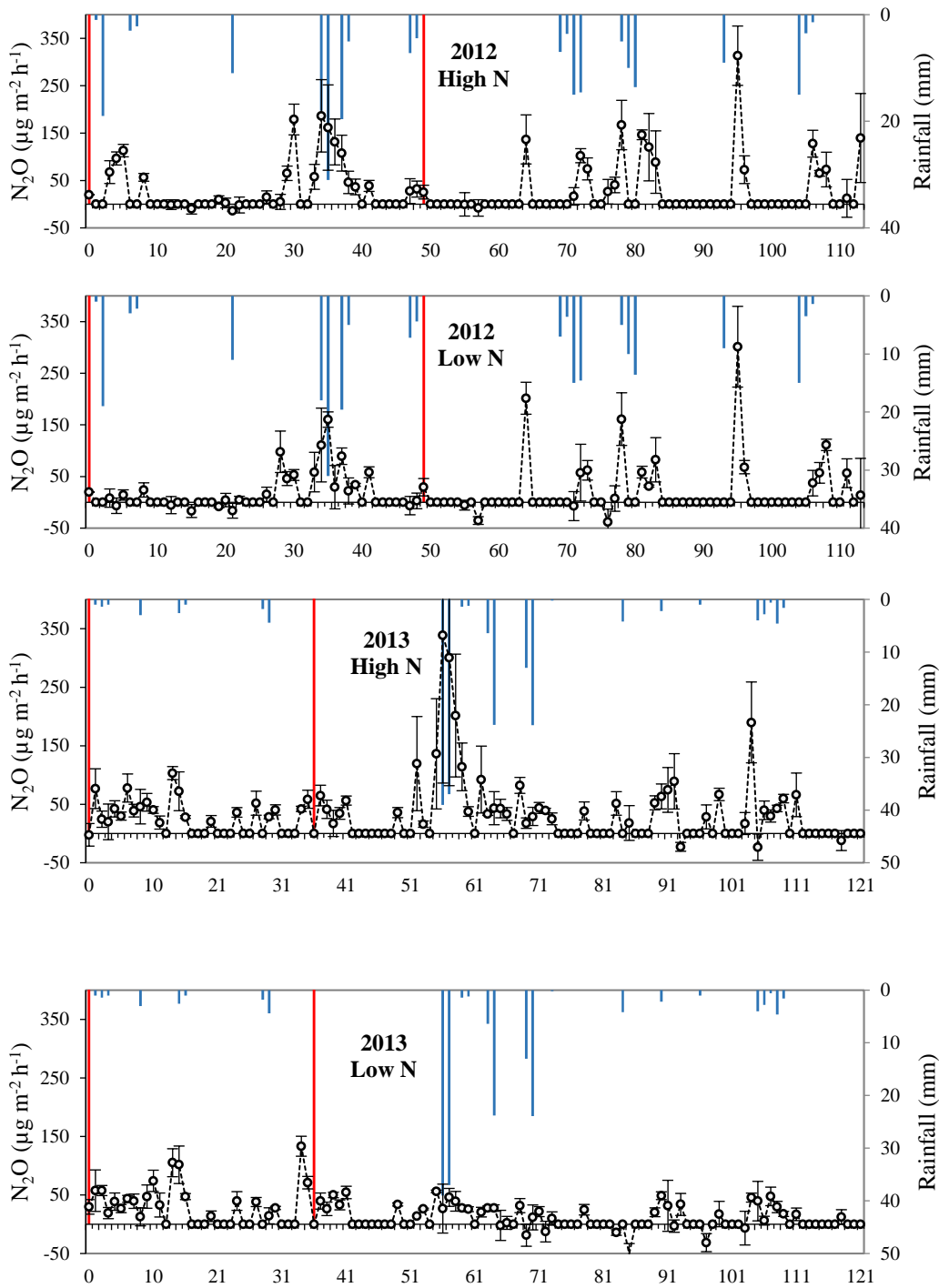

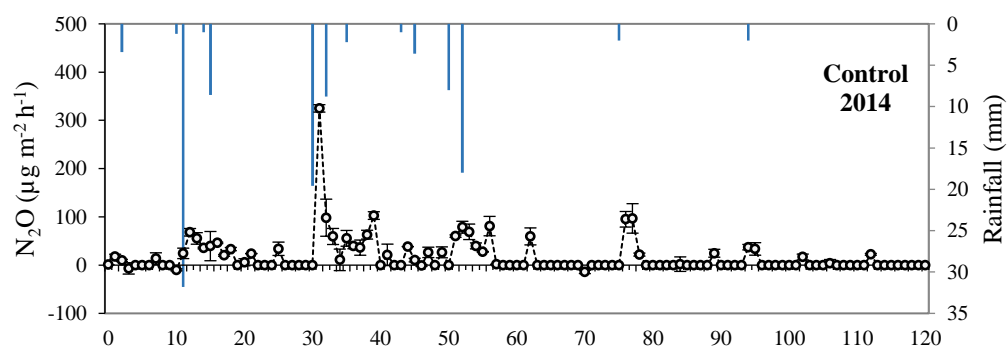
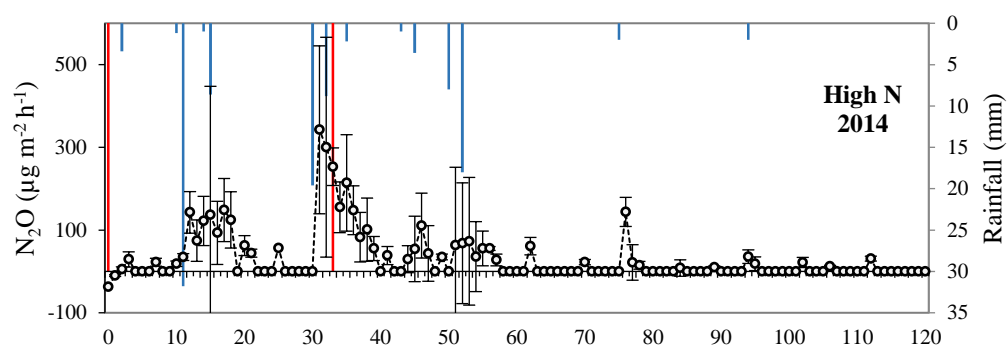
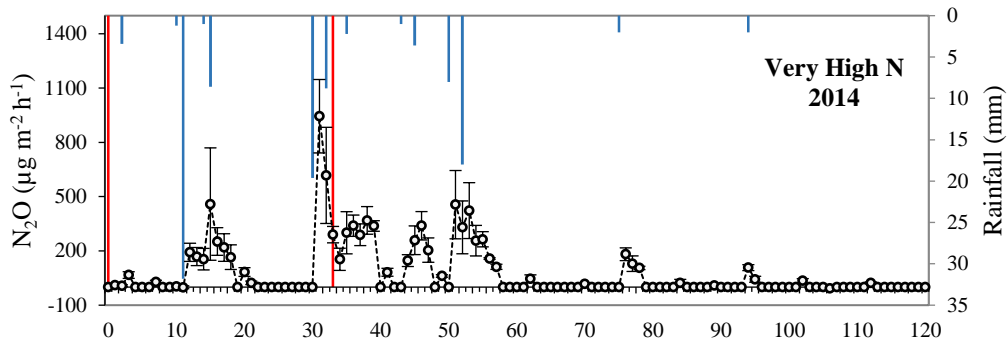

S7 Fig. Average N₂O flux (with ± SE) for groundnut in *rabi* (irrigated season) 2012

This figure shows average N₂O fluxes recorded at replicate treatments. Here, X-axis represents days after sowing. Red lines represent timing of the addition of N fertilizers. Blue lines represent the timing of irrigation. Please note that this data from 2012 has already been published and discussed in Kritee et al (2015). Please notice that the scale of Y axis differs significantly across different treatments.

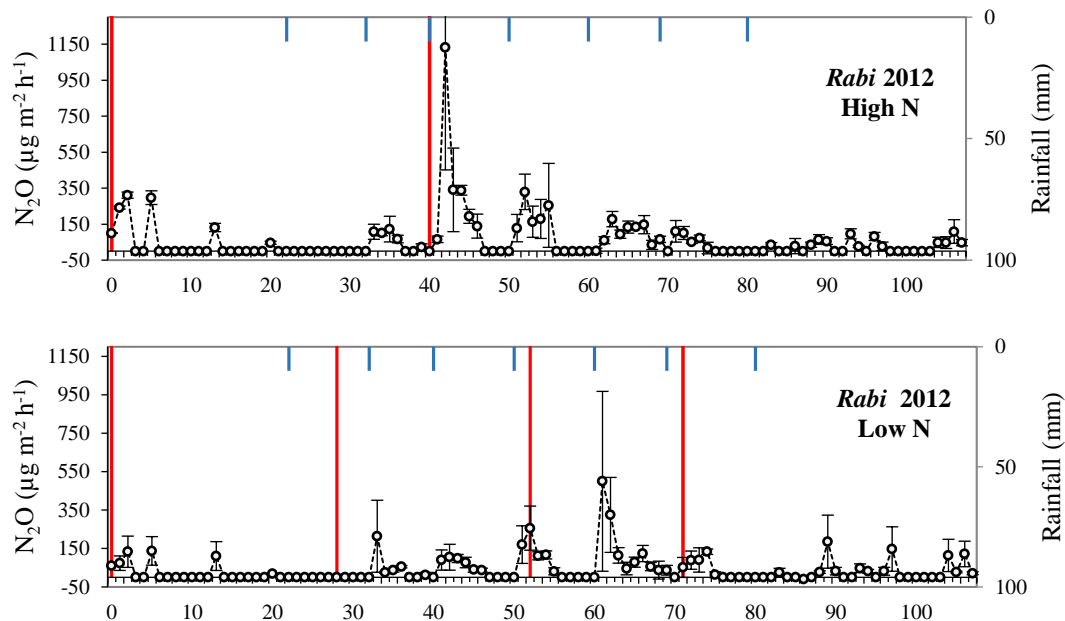

S8 Fig. Frequency distribution graphs of N₂O flux for different replicate finger-millet replicate plots in 2015.

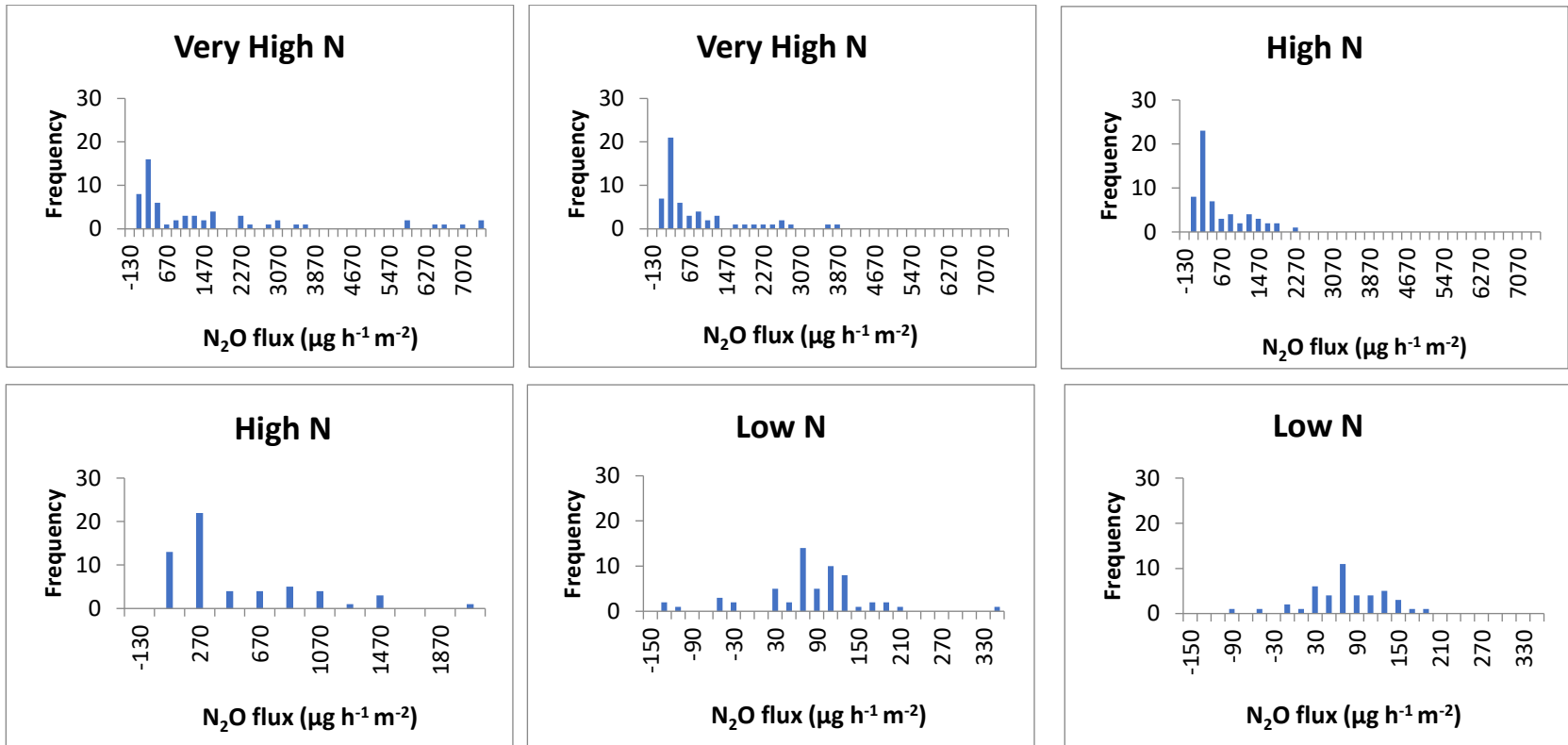

S9 Fig. Frequency distribution graphs of N₂O flux for different replicate finger-millet replicate plots in 2012-2014

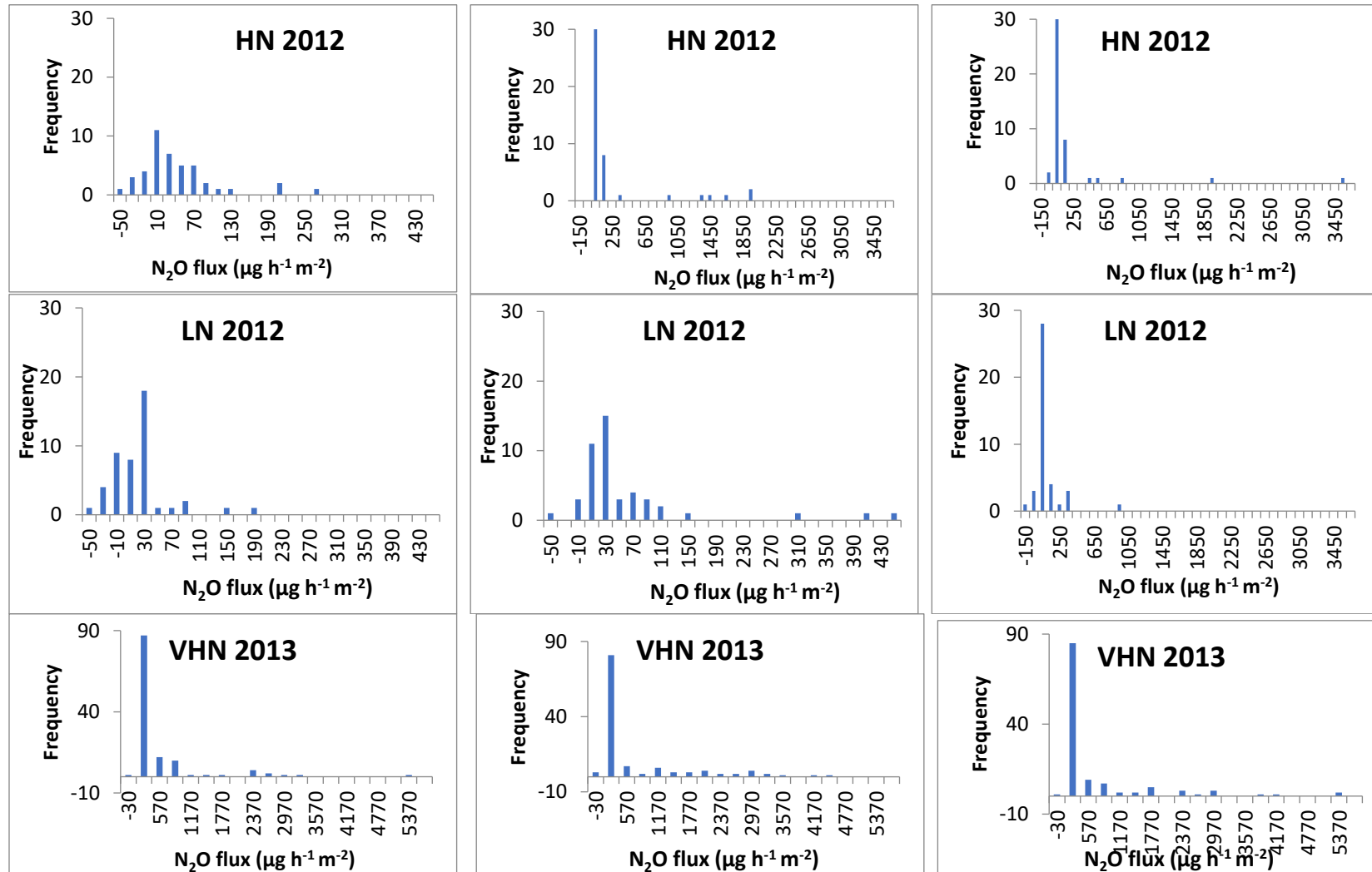

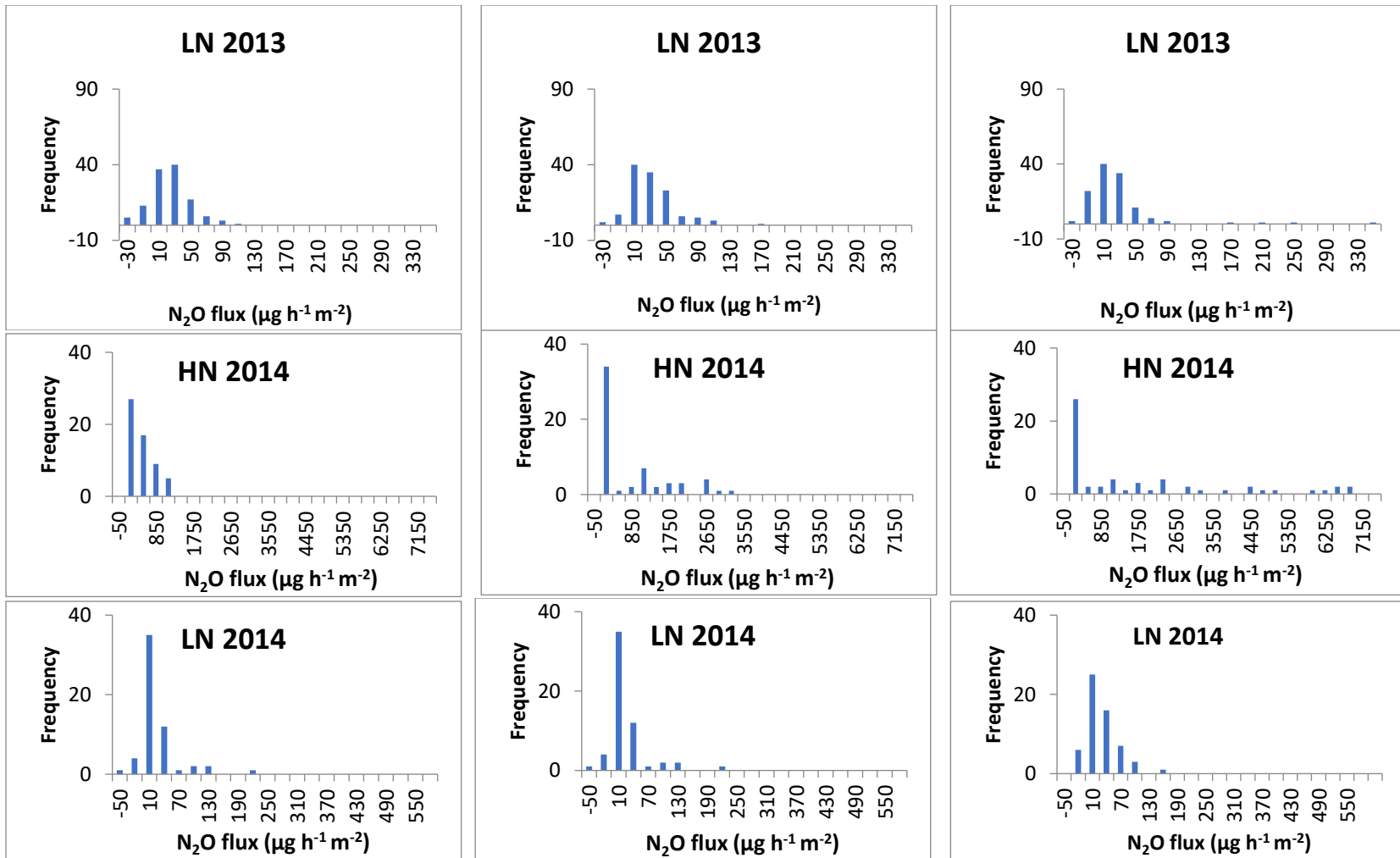

S10 Fig. Frequency distribution graphs of N₂O flux for different replicate foxtail-millet plots in 2014

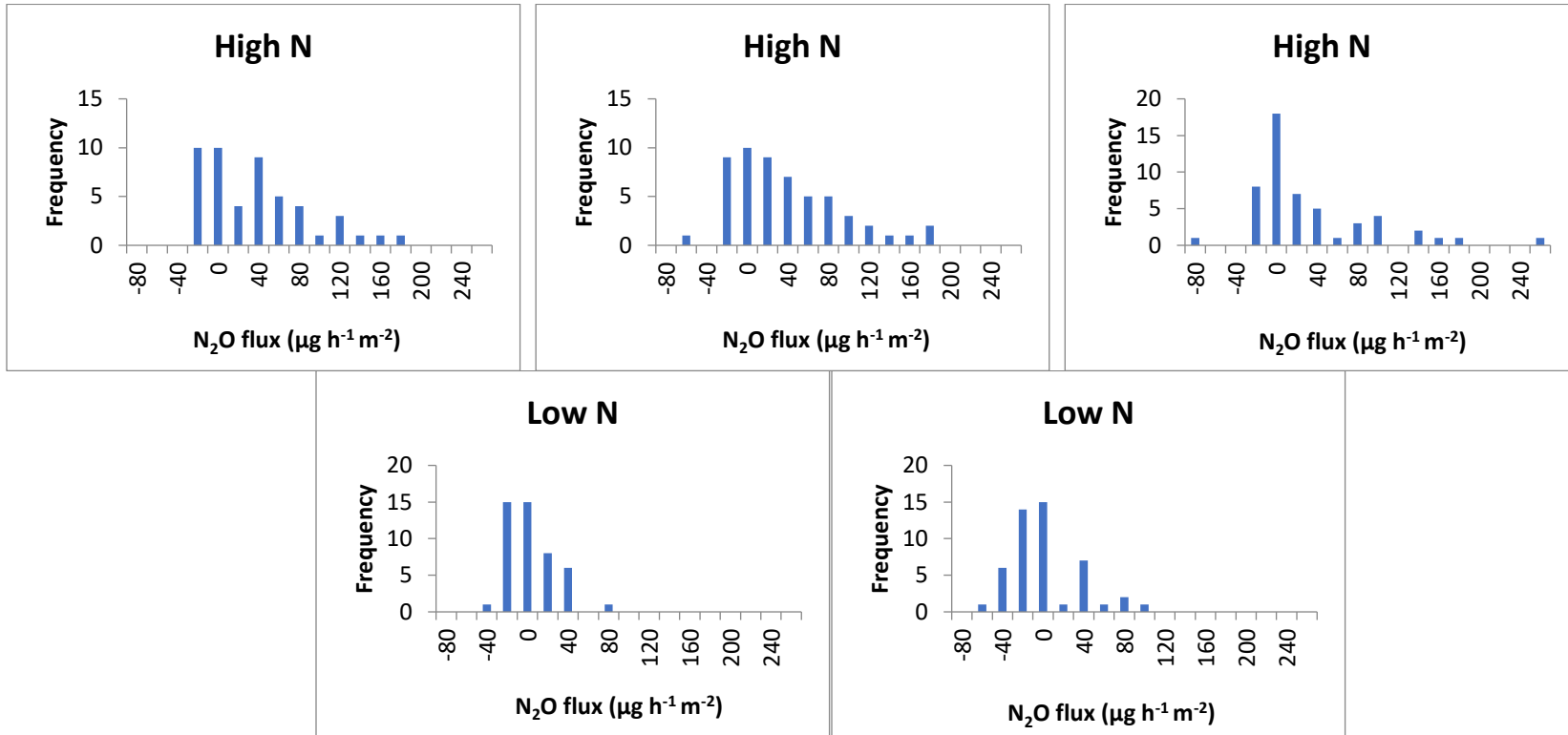

S11 Fig. Frequency distribution graphs of N₂O flux for different replicate groundnut plots in groundnut (*Kharif 2012-2014*)

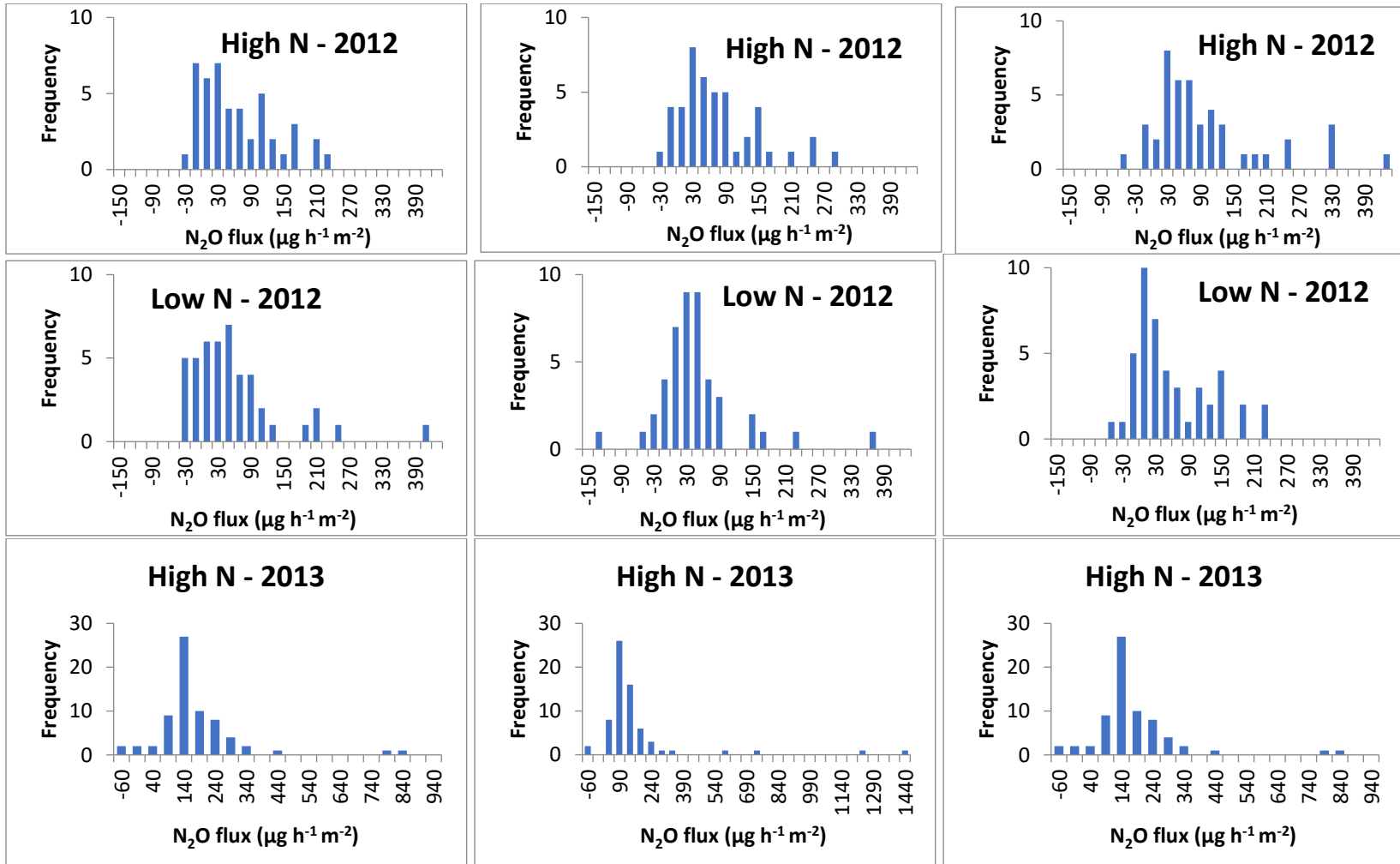

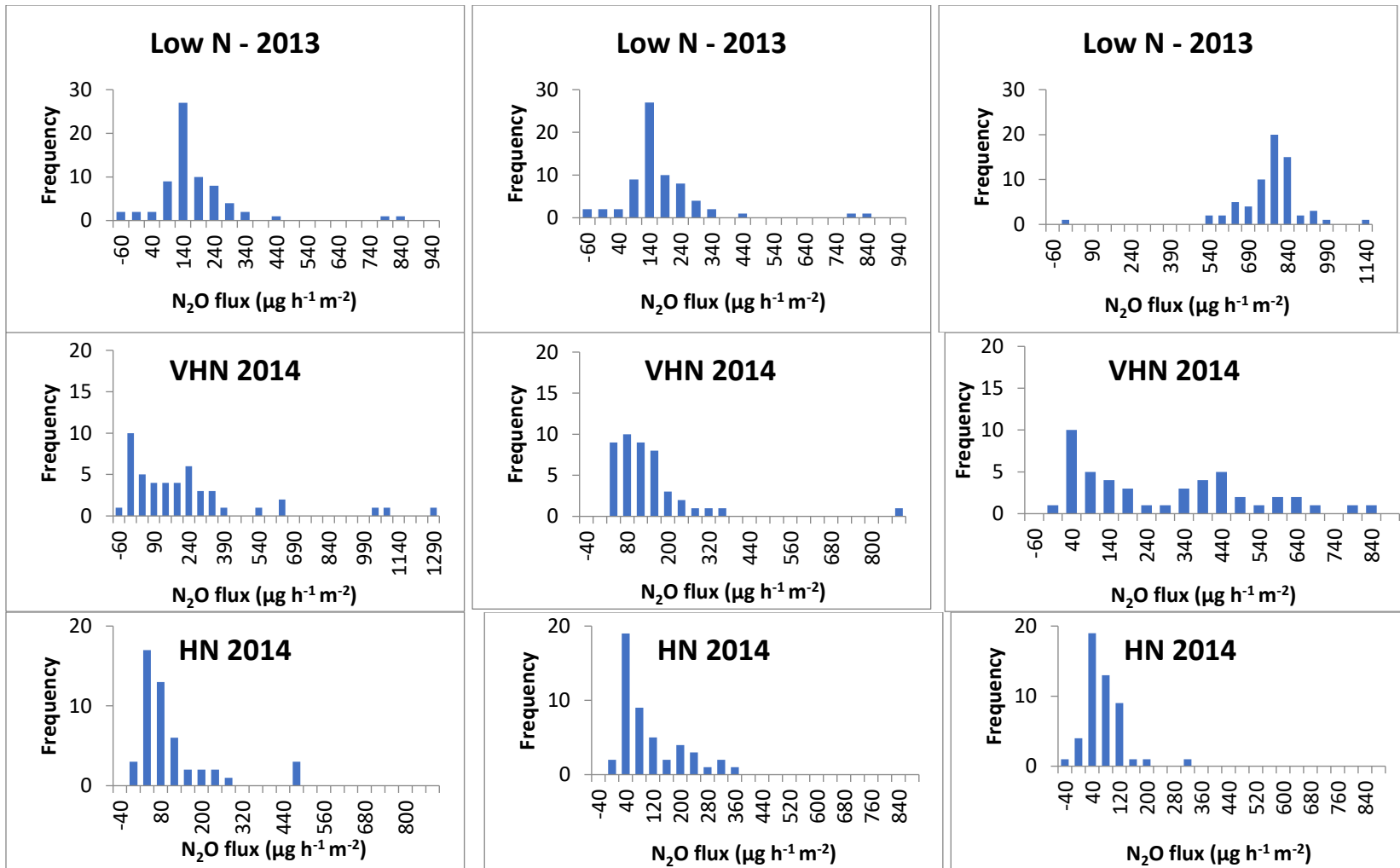

S12 Fig. Frequency distribution graphs of N₂O flux for groundnut in 2012 (*Rabi*)

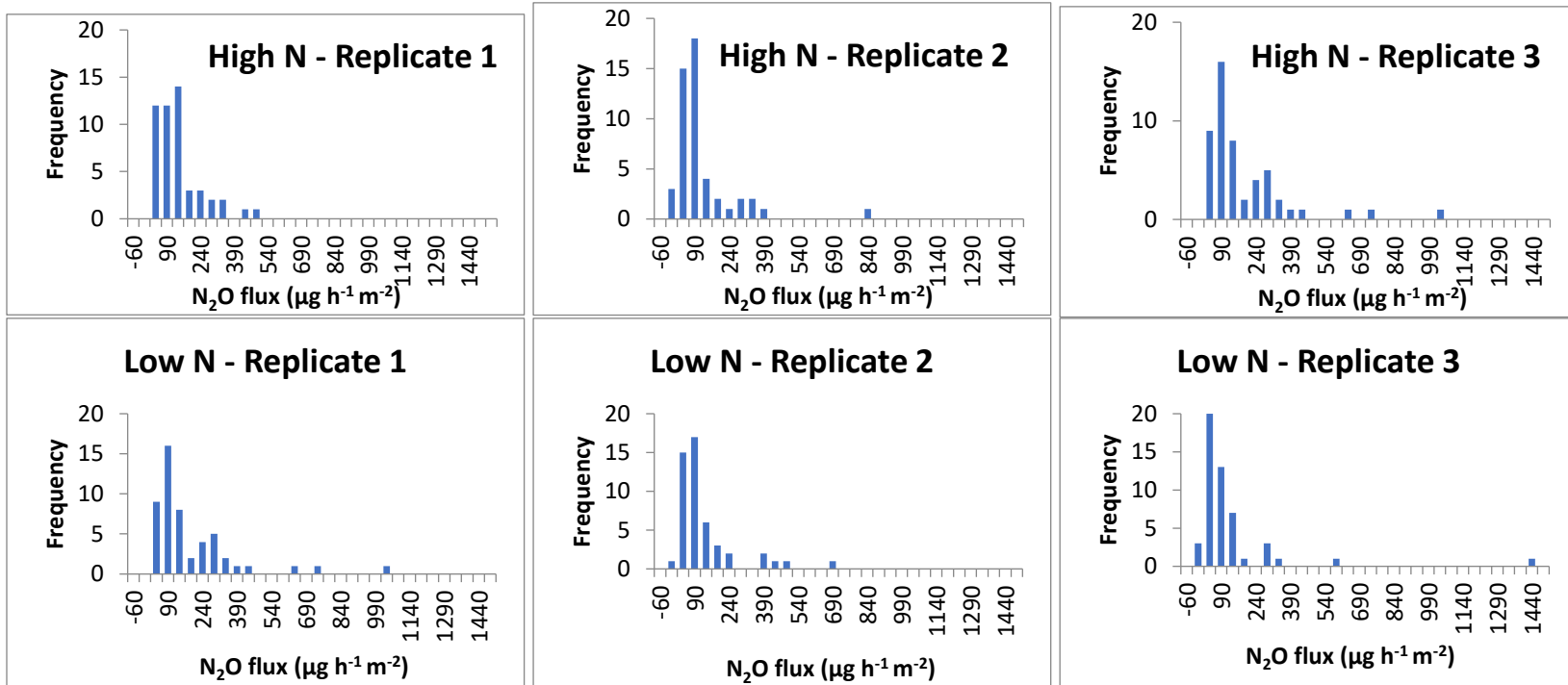

Supporting datasets/tables

Supporting datasets associated with this report (Tables S1 to S13) are available on the Dryad portal at the persistent identifier: <https://doi.org/10.5061/dryad.cfxpvnvx5r>

S1 Table	General site description for all study farms including soil, weather, seed variety, and sampling intensity details
S2 Table	Timing of addition of inorganic and organic fertilizers for all study farms
S3 Table	Summary of baseline farmer survey results compared with actual inputs used for high N treatment plots
S4.1 Table	Cumulative mineralized N input in low rainfall site for finger-millet (2012-2014)
S4.2 Table	Cumulative mineralized N input in high rainfall site for finger-millet (2015)
S5.1 Table	Cumulative mineralized N input during <i>Kharif</i> groundnut season (2012)
S5.2 Table	Cumulative mineralized N input during <i>Rabi</i> irrigated groundnut season (2012)
S5.3 Table	Cumulative mineralized N input during <i>Kharif</i> groundnut cropping season (2013)
S5.4 Table	Cumulative mineralized N input during <i>kharif</i> groundnut cropping season (2014)
S5.5 Table	Cumulative mineralized N input during <i>kharif</i> foxtail-millet cropping season (2014)
S6 Table	Negative nitrous oxide emissions from all cropping seasons except for groundnut <i>kharif</i> and <i>rabi</i> 2012 datasets that have been published earlier (Kritee et al, 2015)
S7.1 Table	Groundnut fertilizer costs
S7.2 Table	Groundnut Labor and machinery costs
S7.3 Table	Groundnut Total Cost of cultivation and Net revenue
S8.1 Table	Finger-millet Fertilizer costs
S8.2 Table	Finger-millet Labor and machinery costs
S8.3 Table	Finger-millet Total Cost of cultivation and Revenue
S9.1 Table	Foxtail-millet Fertilizer and seed costs
S9.2 Table	Foxtail-millet Labor and machinery cost
S9.3 Table	Foxtail-millet Total Cost of cultivation and Revenue (when FYM and fermented manures are freely available)
S10 Table	Parameters considered for multivariate regression of nitrous oxide emissions from groundnut farms
S11.1 Table	Parameters considered for multivariate regression of nitrous oxide emissions from finger-millet farms
S11.2 Table	Parameters considered for multivariate regression of nitrous oxide emissions from foxtail-millet farms
S12 Table	Nitrous oxide emissions at all study farms during fallow periods
S13 Table	Area in agro-ecological region (AER) 8.2 under rainfed ragi cultivation

Supporting references

de Klein, C. et al., 2006. N₂O emissions from managed Soils, and CO₂ emissions from Lime and urea application in 2006 IPCC Guidelines for National Greenhouse Gas Inventories. (Institute for Global Environmental Strategies, Hayama, Japan). pp. 1-54.

Devi, P.B., Vijayabharathi, R., Sathyabama, S., Malleshi, N.G., Priyadarisini, V.B., 2014. Health benefits of finger millet (*Eleusine coracana* L.) polyphenols and dietary fiber: a review. *Journal of Food Science and Technology*, 51(6): 1021-1040.

Dick, J., B. Kaya, et al. (2008). "The contribution of agricultural practices to nitrous oxide emissions in semi-arid Mali." *Soil Use and Management* 24(3): 292-301.

EPI, 2014. Earth Policy Institute, Data Highlights: Many Countries Reaching Diminishing Returns in Fertilizer Use.

FAOSTAT, 2014. Global Crop Production Downloadable Food and Agriculture Organization (FAO) Data. Food and Agriculture Organization.

Gajbhiye, K.S., Mandal, C., 2000. Agro-Ecological Zones, their Soil Resource and Cropping Systems. Status of farm mechanization in India. Nagpur, India: National Bureau of Soil Survey and Land Use Planning.

GOI, 2011. Agriculture Contingency Plan for District Ramanagara (State Karnataka). In: Department of Agriculture & Cooperation, M.o.A.a.F.s.w. (Editor), pp. 1-37.

GOI, 2017. 'Input survey database' of Department of Agriculture & Cooperation, Agricultural Census Division. National Informatics Center. Available at <http://inputsurvey.dacnet.nic.in/nationaltables.aspx> Last accessed on Oct 2017.

GOI, 2019. Government of India, Annual Report 2018-2019, Department of Fertilizers, Ministry of Chemicals and fertilizers. Available at <http://fert.nic.in/page/annual-report>.

GOI, 2021. Government of India, Agricultural Statistics at a Glance 2021 Ministry of Agriculture & Farmers Welfare, Department of Agriculture & Farmers Welfare, Directorate of Economics & Statistics. New Delhi.

GOK, 2015a. Government of Karnataka: District-wise Agricultural holdings and Operated area in Karnataka (2010-11 Agricultural census). Webpage: <http://raitamitra.kar.nic.in/stat/13.htm>.

GOK, 2015b. Government of Karnataka: District/Season-wise normal area under agriculture crops. Webpage: <http://raitamitra.kar.nic.in/stat/21.htm>.

GOK, 2015c. Government of Karnataka: Production of Foodgrains - India & Karnataka 2000-01 to 2012-13. Webpage: <http://raitamitra.kar.nic.in/stat/24.htm>.

ICRISAT, 2015. Finger Millet International Crops Research Institute for the Semi-Arid Tropics (<https://www.icrisat.org/tag/finger-millet/>).

Kritee, K. et al., 2015. Groundnut cultivation in semi-arid peninsular India for yield scaled nitrous oxide emission reduction. *Nutr. Cycl. Agroecosys.*, 103(1): 115-129.

Kritee, K. et al., 2018. High nitrous oxide fluxes from rice indicate the need to manage water for both long- and short-term climate impacts. *Proc. Natl. Acad. Sci.* 10.1073/pnas.1809276115.

Kumar, S., Goyal, S.K., Kumar, A., 2011. A study on design and development of NADEP compost tank. *Progressive Agriculture*, 11(1): 207-209.

- Lata, C., Gupta, S., Prasad, M., 2013. Foxtail millet: a model crop for genetic and genomic studies in bioenergy grasses. *Critical Reviews in Biotechnology*, 33(3): 328-343.
- Lesschen, J. P., G. L. Velthof, et al. (2011). "Differentiation of nitrous oxide emission factors for agricultural soils." *Environmental Pollution* 159(11): 3215-3222
- Majumdar, D., 2000. Monitoring and mitigation of nitrous oxide emissions from agricultural fields of India: Relevance, problems, research and policy needs. *Current Science*, 79(10): 1435-1439.
- MoA, 2014. Status paper on coarse cereals (Sorghum, Pearl Millet, Finger Millet, Small Millets, Maize and Barley) by Ministry of Agriculture (India), Department of Agriculture and Cooperation, Jaipur, Directorate of Millets Development.
- Mohanty, M. et al., 2011. Modelling N mineralization from green manure and farmyard manure from a laboratory incubation study. *Ecological Modelling*, 222(3): 719-726.
- Parkin, T.B., 2008. Effect of sampling frequency on estimates of cumulative nitrous oxide emissions. *J Environ Qual*, 37(4): 1390-5.
- Parkin, T. B. and T. C. Kaspar (2006). "Nitrous oxide emissions from corn-soybean systems in the midwest." *J Environ Qual* 35(4): 1496-1506.
- PennState, 2016. Determining Nutrient Applications for Organic Vegetables – Basic Calculations. Introduction to Soils. In: Extension, P. (Editor). PennState College of Agricultural Sciences.
- Pratt, P.F., Castellanos, J.Z., 1981. Available nitrogen from animal manures. *California Agriculture*, 35(7): 24.
- Sharma, V.P., Thaker, H., 2011. Demand for Fertiliser in India: Determinants and Outlook for 2020, Ahmedabad.
- Shcherbak, I., N. Millar, et al. (2014). "Global metaanalysis of the nonlinear response of soil nitrous oxide (N₂O) emissions to fertilizer nitrogen." *Proceedings of the National Academy of Sciences* 111(25): 9199-9204.
- Shimizu, M. et al., 2009. The effect of manure application on carbon dynamics and budgets in a managed grassland of Southern Hokkaido, Japan. *Agriculture, Ecosystems & Environment*, 130(1-2): 31-40.
- Shimizu, M. et al., 2010. Nitrous oxide emissions and nitrogen cycling in managed grassland in Southern Hokkaido, Japan. *Soil science and plant nutrition*, 56(4): 676-688.
- Snyder, C.S., Bruulsema, T.W., Jensen, T.L., Fixen, P.E., 2009. Review of greenhouse gas emissions from crop production systems and fertilizer management effects. *Agriculture, Ecosystems & Environment*, 133(3-4): 247-266.
- Thilakarathna, M., Raizada, M., 2015. A Review of Nutrient Management Studies Involving Finger Millet in the Semi-Arid Tropics of Asia and Africa. *Agronomy*, 5(3): 262.
- TNAU, 2017. Millet: Ragi Crop Production Guide in Tamil Nadu Agricultural University (TNAU) Agritech portal. http://agritech.tnau.ac.in/agriculture/millets_ragi.html.
- Upadhyay, R. K., D. D. Patra, et al. (2011). "Natural nitrification inhibitors for higher nitrogen use efficiency, crop yield, and for curtailing global warming." *Journal of Tropical Agriculture* 49: 19-24.
- van Groenigen, J.W., Velthof, G.L., Oenema, O., Van Groenigen, K.J., Van Kessel, C., 2010. Towards an agronomic assessment of N₂O emissions: a case study for arable crops. *European Journal of Soil Science*, 61(6): 903-913.
- Veeramani, P. and K. Subrahmaniyan (2011). "Nutrient Management for sustainable Groundnut Productivity in India- a review." *International Journal of Engineering Science and Technology* 3(11): 8138-8153. *Journal of Tropical Agriculture* 49: 19-24.